



Advanced Dungeons & Dragons[®]
2nd Edition

DLE2
9244

DRAGONLANCE[®]

Official Game Adventure

DRAGON MAGIC

BY RICK SWAN

Compatible with
the AD&D[®] and
the 2nd Edition
AD&D[®]
Game Systems.

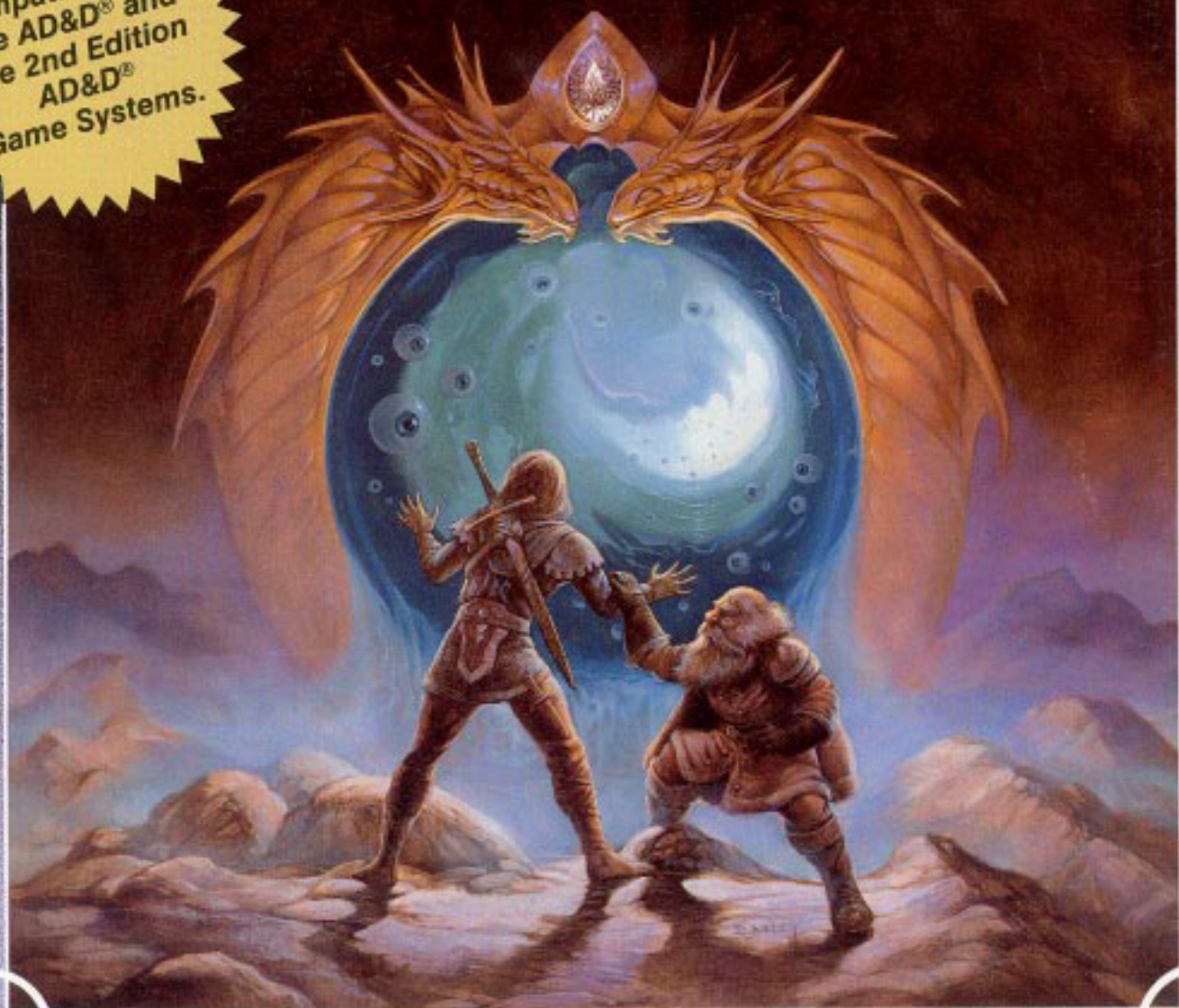

Second in the exciting series of adventures set in the
fantastic world of the DRAGONLANCE[®] Saga!

NON-PLAYER STATISTICS

PEOPLE

Andru, Cinda or boy with octopus: AC 10; MV 12; F1; hp 5 each; #AT 1; Dmg by weapon; AL LG; THACO 20.

Crouse, 6th level Cleric of Evil: AC 10; MV 12; hp 35; #AT 1; Dmg by weapon; SA spells; AL LE. Equipment: *staff of striking* (12 charges); THACO 18

Spells:

1st level: *detect good, light x2*

2nd level: *resist fire, find traps x2*

3rd level: *dispel magic, feign death*

Finion Pel: AC 3; MV 12; F7; hp 37; #AT 1; Dmg 1d8 + 2 (long sword +2); AL LE. Equipment: chain mail, *ring of fire resistance, long sword +2*; THACO 12 (14)

Kroghir, 6th level Cleric of Evil: AC 10; MV 12, hp 35; #AT 1; Dmg by weapon; SA spells; AL LE. Equipment: *helm of teleportation*; THACO 18;

Spells:

1st level: *create water, light x2*

2nd level: *slow poison, find traps x2*

3rd level: *dispel magic, feign death*

Wemitowuk

Chief Owalago: AC 10; MV 12; F4; hp 23; #AT 1; Dmg by weapon; AL NG; THACO 17.

Chief Talawillona: AC 10; MV 12; F4; hp 30; #AT 1; Dmg by weapon; AL NG; THACO 17.

Pawjada: AC 10; MV 12; F2; hp 15; #AT 1; Dmg by weapon; AL NG; THACO 20.

Tribesman: AC 10; MV 12; F1; hp 8 each; #AT 1; Dmg by weapon; AL NG; THACO 20.

DRAGONKIND

GOOD

Hatchling copper dragons (3): AC 1; MV 9, FI 24; HD 8; hp 8 each; #AT 3; Dmg 1d4/1d4/5d4; SA breath weapon (7-foot x 1/2-foot acid discharge or 3-foot x 2-foot x 2-foot cloud causing slow on any creature failing save vs. dragon breath); AL CG; THACO 12.

Kerrija, young silver dragon: AC -1; MV 9, FI 24; HD 10; hp 20; #AT 3; Dmg 1d6/1d6/5d6; SA breath weapon (cone of frost 8 feet long with a 3-foot base. or cloud of paralyzing gas 5 feet x 4 feet x 2 feet taking immediate effect unless target successfully saves vs. breath weapon) and spells; AL LG; THACO 10.

Spells:

1st level: *detect evil, cure light wounds*

Lei, bronze wyrm: AC 0; MV 9, FI 24; HD 8; hp 40 (reduced due to injuries); #AT 3; Dmg 1d6/1d6/4d6; SA breath weapon (bolt of lightning 10" x 1/2" or gas cloud 2" x 3" x 3" which *repulses* creatures who fail to save vs. breath for 6 rounds); AL LG; THACO 12.

Moonscale, venerable bronze dragon: AC 0; MV 9, FI 24; HD 8; hp 40 (reduced due to injuries); #AT 3; Dmg 1d6/1d6/4d6; SA breath weapon (bolt of lightning 10" x 1/2" or gas cloud 2" x 3" x 3" which *repulses* affected creatures for 6 minutes who fail save vs. dragon breath); AL LG; THACO 12.

Papian, young adult bronze dragon: AC 0; MV 9, FI 24; HD 9; hp 36; #AT 3; Dmg 1d6/1d6/4d6; SA breath weapon

(bolt of lightning 10 feet x 1/2 foot or gas cloud 2 feet x 3 feet x 3 feet which *repulses* affected creatures for 6 rounds who fail save vs. dragon breath), spells; AL LG; THACO 12.

Spells:

1st level: *magic missile, comprehend languages*

2nd level: *continual light, detect invisibility*

Steel-Eye, venerable gold dragon: AC -2; MV 12, FI 30; HD 10; hp 80; #AT 3; Dmg 1d8/1d8/6d6; SA breath weapon (fire in a 9-foot x 3-foot cone or chlorine gas in a 5-foot x 4-foot x 3-foot cloud), *polymorph* three times per day, spells; AL LG; THACO 10.

Spells:

1st level: *detect good, magic missile*

2nd level: *invisibility, detect invisibility*

3rd level: *fireball, lightning bolt*

4th level: *fire shield, ice storm*

5th level: *cone of cold, passwall*

6th level: *disintegrate, project image*

Terrilyn, young silver dragon: AC -1; MV 9, FI 24; HD 10; hp 20; #AT 3; Dmg 1d6/1d6/5d6; SA breath weapon (cone of frost 8 feet long with a 3-foot base. or cloud of paralyzing gas 5 feet x 4 feet x 2 feet taking immediate effect unless target successfully saves vs. breath weapon); AL LG; THACO 10.

Trillum, young brass dragon: AC 2; MV 12, FI 24; HD 8; hp 16; #AT 3; Dmg 1d4/4-16/1d4; SA breath weapon (cone of sleep gas extending 7 feet with a base diameter of 2 feet, or a cloud of fear gas 4 feet wide x 5 feet across x 2 feet deep; AL CG; THACO 12.

EVIL

Izark, young white dragon: AC 3; MV 12, FI 3 0; HD 7; hp 14; #AT 3; Dmg 1d4/1d4/2d8; SA breath weapon (cone of frost 7 feet long with 2 1/2-foot- diameter base; AL CE; THACO 13.

Nightclaw, young adult black dragon: AC 3; MV 12, FI 24; HD 8; hp 12; #AT 3; Dmg 1d4/1d4/3d6; SA breath weapon (spit acid in a 1/2-foot-wide stream for 6 feet in a straight line for dmg 2d4); AL CE; THACO 12.

Young blue dragons (3): AC 3; MV 12, FI 24; HD 8; hp 12 each; #AT 3; Dmg 1d4/1d4/3d6; SA breath weapon (); AL CE; THACO 12.

Young adult red dragon: AC -1; MV 9, FI 24; HD 9; hp 27; #AT 3; Dmg 1d8/1d8/3d10; SA breath weapon (cone of fire 9 feet long with 3-foot-diameter base); AL CE; THACO 12.

NEUTRAL

Abriele, kodragon: AC 5; MV 6, FI 24; HD 5; hp 30; #AT 3; Dmg 1d2/1d2/1d6; SA breath weapon (10-foot cloud of shrinking gas causes victim to shrink to 5% of normal size, or 10-foot cloud of cancellation of shrinking gas which negates effect of shrinking gas breath weapon; both breath weapons can affect inanimate objects); SD *teleport without error* and *plane shift* at will; AL N (G); THACO 15.

Dira, Abriele's baby kodragon: AC 5; MV 1, FI 4; HD 5; hp 5; #AT 3; Dmg 1/1/1d2; SD *teleport* and *plane shift* at will; AL N; THACO 18.

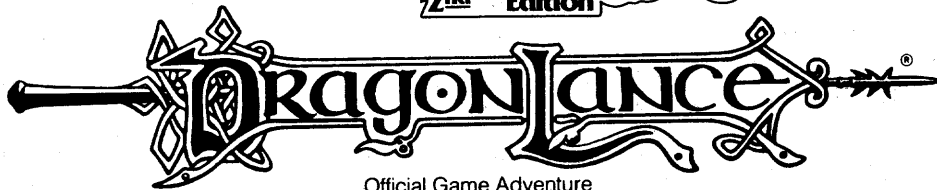

Official Game Adventure

DRAGON MAGIC

by Rick Swan

Table of Contents

INTRODUCTION.....	2
PROLOGUE: EARS OF CORN	5
CHAPTER 1: CITY OF CLOUDS	12
CHAPTER 2: NIGHT OF FIRE	26
CHAPTER 3: GARDEN OF THE DEAD	40
CHAPTER 4: ISLE OF DRAGONS	51
EPILOGUE.....	61
NEWMONSTERS.....	62
MAPS 2-5.....	30-31, 33-34
MOON TRACKING CHART	32
PRE-GENERATED CHARACTERS	GATEFOLD
NONPLAYER STATISTIC.....	INSIDE MODULE COVER

Credits

Editing: David Ladyman
Cover Art: Jeff Easley
Interior Art: Karl Waller

Cartography: Diesel
Typography: Gaye O'Keefe
Graphic Design: Stephanie Tabat

TSR, Inc.
POB 756
Lake Geneva
WI 53147 USA

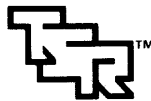

TSR, Inc.
PRODUCTS OF YOUR IMAGINATION™

TSR Ltd
120 Church End, Cherry Hinton
Cambridge CB1 3LB
United Kingdom

©1989 TSR, Inc. All Rights Reserved.

ADVANCED DUNGEONS & DRAGONS, AD&D, DRAGONLANCE, PRODUCTS OF YOUR IMAGINATION, and the TSR logo are trademarks owned by TSR, Inc.

Distributed to the book trade in the United States by Random House, Inc., and in Canada by Random House of Canada, Ltd. Distributed to the toy and hobby trade by regional distributors. Distributed in the United Kingdom by TSR Ltd.

This adventure is protected under the copyright laws of the United States of America. Any reproduction or other unauthorized use of the material or artwork contained herein is prohibited without the express written consent of TSR, Inc.

Printed in the U.S.A.
0-88038-740-8
9244XXX2001

Permission granted to photocopy or print this product for personal use.

INTRODUCTION

Dragon Magic is the second of three modules in an epic DRAGONLANCE® series. The first module, *In Search of Dragons*, began with an investigation of the disappearance of the good dragons and led to the reaffirmation of an ancient, sacred bond between the good dragons and the good races of Krynn. This module continues with the discovery of a secret dragon city in the clouds and climaxes with a dramatic confrontation on the legendary Isle of Dragons.

All modules in the series are self-contained and can be played independently. However, if you plan to play the entire series, the modules should be played in order.

The following information is for the eyes of the DM only. The DM is advised to familiarize himself with the entire adventure before beginning play.

PLAYER CHARACTERS

Pre-generated characters are provided on the module cover. If the players completed the module, "In Search of Dragons," they may continue with the same characters, retaining any equipment acquired in that first adventure.

If a PC was killed in the first module, the player may choose an unused character or change the name and background of the character and use the same statistics and equipment. (For instance, if Blackstar was killed in the previous module, his brother, Graystar, might take over for this adventure. Graystar would use the statistics and equipment given on Blackstar's character card.)

With the DM's approval, players may modify the pre-generated characters or use their own characters. A balanced mix of character classes is suggested, but none may be of evil alignment.

THE WORLD OF KRYNN

There are several important differences between the world of Krynn and standard AD&D® game adventure settings.

Currency. Instead of gold, steel is the most precious metal on Krynn and is Krynn's basic unit of currency. One steel piece (stl) has the equivalent purchasing power of one gold piece in a regular AD&D campaign. A gold piece is the equivalent of a regular AD&D game silver piece.

Clerics. Centuries ago, Krynn was nearly destroyed by a Cataclysm inflicted by the gods as punishment for the arrogance of its inhabitants. The Cataclysm removed all knowledge of the true gods and also took away all clerical abilities. The existence of the true gods was rediscovered during the War of the Lance.

True clerics now wear a Medallion of Faith bearing the symbol of their god. All PC clerics participating in this campaign must be of good alignment and follow a god of good, most likely Mishakal, the goddess of healing, or Paladine, the Father of Good and Master of the Law. All PC clerics have normal clerical abilities, including spell casting and turning of undead.

Kender. Kender are the equivalent of halflings on Krynn. They resemble wizened 14-year-olds with bright eyes and pointed ears, are insatiably curious, and are completely immune to all types of *fear*.

In addition to the standard halfling abilities, kender have the special ability to taunt opponents into reckless attacks by verbally abusing them. Any creature taunted by a kender must save vs. spells or attack wildly for 1-10 rounds at a -2

penalty for all attack rolls and a +2 penalty to its Armor Class.

Elves. There are three common types of elves on Krynn. The fair-skinned and light-haired Silvanesti (High Elves) are intolerant and suspicious of all other races. Qualinesti elves are slightly smaller and darker than the Silvanesti. Their society is less structured and they are friendly toward other races, enjoying a generally cooperative relationship with humans. Kagonesti (Wild Elves) are muscular nomads, fierce and independent. Krynn elves have all of the elvish abilities described in the *Player's Handbook*.

Dwarves. The two most common types of dwarves on Krynn are the mountain and hill races. Both are stubborn and strong-willed, though hill dwarves are less sophisticated and somewhat gentler. A third type, gully dwarves, are considered to be stupid, filthy, and repulsive creatures, shunned by all civilized inhabitants of Krynn.

PC dwarves are hill dwarves. Krynn dwarves have all of the dwarvish abilities described in the *Player's Handbook*.

ADVENTURING IN KRYNN

A successful DRAGONLANCE adventure has the feel of an epic novel in which the player characters are vital participants. DRAGONLANCE adventures also stress a value system based on strong principles—that persevering forces of good can triumph over evil, and that good actions have good consequences, while evil actions have evil consequences. This adventure is based on these principles, and the DM should make sure that they hold true.

RUNNING THE ADVENTURE

ORGANIZATION

The adventure begins with the events of the Prologue and ends with the Epilogue. In between are the four main adventure chapters. These chapters occur chronologically, so the PCs will move through them in sequence, from 1 through 4.

Each chapter begins with background information and an overview which includes the chapter's major goals and discoveries. Each chapter ends with a troubleshooting section—tips for handling unexpected problems.

Boxed text may be read directly to the players, or it may be paraphrased by the DM.

MAPS

The enclosed fold-out color map shows the cloud city of Cirulon as it appears when the PCs arrive in Chapter 1. Other pertinent maps are included in the center pull-out section of the module.

ENCOUNTERS

Encounters are adventure episodes keyed to designated locations on the maps. Encounters may be keyed to outdoor areas, rooms of a building, or even objects, such as the art works in the galleries Cirulon. When the PCs enter a new area or room, or approach an object, the encounter occurs immediately. In some cases, the text explains what happens if the PCs make a return visit. Otherwise, either rerun the same encounter or use common sense (for instance, if a

sculpture exploded after someone touched it, the sculpture is no longer there if the party returns).

THE MOONS OF KRYNN

The positions of Krynn's moons play an important part in this adventure. The Moon Tracking Chart in the center pull-out section should be used to note the locations of the moons.

If you played the first module and noted the locations of the moons at the end, you can begin this adventure 28 days after the end of the last one. Otherwise, roll 1d8 for each moon and place a coin or marker in the indicated box along its orbit. Advance the moons one box per game day to keep track of their positions.

Note that each of the three Orders of High Sorcery receives its powers from one of the moons. Wizards of the White Robes obtain their powers from Solinari, Black Robe wizards from Nuitari, and Red Robe wizards from Lunitari. Each phase of a moon has an effect on the magic of the appropriate order of wizards.

Moon Phase Effects Table*

Moon Phase	Saving Throws	Additional Spells **	Effective Level
Low Sanction	- 1	0	- 1
Waning	Normal	0	Normal
Waxing	Normal	+1	Normal
High Sanction	+1	+ 2	+1 ***

* A wizard of level 1-3 is unaffected by phases of the moon because of the low power levels involved in his spells.

** The additional spells can be of any level the wizard can cast.

*** Only a wizard of 6th level or higher who also has an Intelligence of 15 or above gains this benefit from the moons.

If two or more of the moons are aligned, there are bonuses to the moon phase effects. (Two (or all three) moons are aligned if any part of the boxes they occupy overlap each other. For example, if Nunitari is in box 5, it would be aligned with Lunitari in boxes 1 or 2, and with Solinari in boxes 2 through 3.) These bonuses are cumulative with modifiers from other effects.

Moon Alignment Effects Table

Alignment	Saving Throws	Additional Spells	Effective Level
Sol. and Lun.	+1	+1	+1
Nuit. and Lun.	+1	+1	+1
Sol. and Nuit.	+1	0	Normal
All three	+2	+2	+1

ABILITY CHECKS

Occasionally a PC is required to make an Ability Check against one of his attributes. This check is referred to as a Strength Check, Intelligence Check, etc., based on the attribute being checked.

To make an Ability Check, roll 1d20 and compare the result to the character's appropriate attribute score. If the roll is less than or equal to the character's attribute, the action being checked succeeds. If the roll is higher, the action fails and the character suffers the indicated consequences. (Checks against 18/100 attributes still fail if a 19 or 20 is rolled.)

THE STORY So FAR

Note to the DM: The following section summarizes the events of the first module, "In Search of Dragons." If you've played that module, feel free to incorporate any details from your version of the story, taking care not to alter the basic plot.

THE FADING MOONS

Since the dawn of time; there has been no deity more feared than Takhisis, the Queen of Darkness. An awesome goddess of nearly limitless power, it was Takhisis who instigated the All-Saints War and who was primarily responsible for the separation of the gods. Takhisis has devoted centuries in pursuit of her vicious obsession (md) the conquest of all other gods and the control of all creation.

The year 333 in the Age of Dragons found Takhisis engaged in a plan that would erupt in the War of the Lance and nearly destroy Krynn. Under her direction, the evil dragons had stolen a sizeable cache of good dragon eggs and extracted an Oath of Neutrality from the good dragons. While the good dragons languished helplessly on the Isle of Dragons, Dragon Highlords were recruited and evil armies gathered under the guidance of the evil dragons.

Anticipating victory, Takhisis sought the companionship of her consort, Sargonnas, for a celebratory spree. But Sargonnas spurned her, angry that he had not been included as a partner in her plans. Furious at Sargonnas's rejection, Takhisis turned to Chemosh, Lord of the Undead, for solace.

As a result of this brief liaison, Takhisis bore a daughter, naming her Artha. Squat, homely, and utterly lacking in ambition, Artha quickly became an embarrassment to her parents. Chemosh disowned her, as did Takhisis when Artha showed no interest in her mother's quest for power.

Disgusted, Takhisis banished Artha from her presence. Artha eventually drifted to Krynn, and, while the War of the Lance raged around her, she quietly accumulated immense caches of treasure which she stored in secret citadels deep beneath the sea, occasionally engaging in random acts of destruction and murder to amuse herself. Though Artha didn't know it, Takhisis was watching her closely.

In the year 344, a renegade Black Robe wizard named Tarligor became fascinated with draconians, the mysterious lizard-like humanoids derived from corrupted eggs of the good dragons. Tarligor conducted secret experiments in a laboratory deep in the Shadowglades, a desolate swamp in northern Estwilde. He was attempting to develop an enhanced draconian, which he believed would ingratiate him with the Highlords and earn him a comfortable position in their empire.

Calling on dark spirits and tapping into arcane black magical forces, Tarligor succeeded in transforming a captured draconian into an entirely new life form. He named his creation Khardra, a term from an ancient Black Robe dialect meaning "corrupt flesh." But before Tarligor could take advantage of his creation, Khardra brutally killed him, then vanished into swamp.

Three years later, Khardra met Artha. It was love at first sight, and from that day on the two were inseparable. Along with recreational destruction, they regularly enjoyed "blending" their spirits, a process which energized and revitalized them by uniting their essences. So intense was this fusion of dark souls that each "blending" seemed to siphon light from the stars and the moons, a phenomenon that amused them to no end.

Unknown to Artha and Khardra, the dimming moons were weakening the good dragons of Krynn. Many of them became disoriented, even disabled. The dragons had no idea what was causing this.





But Takhisis knew. She had been observing the antics of Artha and her love for some time and had determined that their blending rituals were draining light from the celestial bodies, which in turn was sapping the good dragons. She was not certain why this was happening—there was no connection between the moons of Krynn and the good dragons that she knew of—but the effects were clear.

Takhisis contacted Artha and Khardra and encouraged them to continue their blending, promising Artha wealth beyond her wildest dreams and Khardra a share in the rule of Krynn if they cooperated. Takhisis knew that if Artha and Khardra were successful in destroying the good dragons, her conquest of Krynn was just a matter of time.

THE SACRED BOND

However, Takhisis was only partially correct as to the reason for the good dragons' weakness. They draw strength from the light of the heavenly bodies, but there is another factor which affects them as well.

A mystical bond exists between good dragons and good people, based on mutual trust, respect, and cooperation. When the bond is strong, both dragons and people flourish, able to function at the peak of their talents and abilities. But when the bond is threatened by doubt, disrespect, or disharmony, both dragons and people suffer and regress. Takhisis, along with the vast majority of people and dragons, is unaware of the significance of this bond.

Because of the exploitation and lax treatment of good dragons by the folk of Krynn since the War of the Lance, this special bond existing between good dragons and good people has been weakened. If it had not been jeopardized, the good dragons would have been able to resist the debilitating effects of the fading moons. The weaker the good dragons became, the more the bond was jeopardized. The more the bond was jeopardized, the weaker the dragons became from the fading moons.

Thanks to the efforts of a handful of brave companions, the threat to the moons was finally ended. Investigating in the countryside of northern Estwilde, the companions discovered the danger of Artha and Khardra's blending ceremonies and the existence of a mysterious disease that was killing the silver dragons. With the help of the courageous Saramber, a beautiful silver dragon who died from the deadly disease, they also learned of the significance of the sacred bond between good dragons and good people.

Artha and Khardra held their final blending ceremony atop the Peak of Clouds, the highest point of the Astivar Range in northern Estwilde. An attack from a conclave of good dragons resulted in the destruction of Khardra when his draconian bones exploded. Furious at Artha's failure to carry out her end of their plan, Takhisis appeared as a five-headed dragon and engulfed her daughter, sweeping her away into the Abyss.

Though this ended the immediate crisis, many questions lingered. Where had all the good dragons gone? What could cure the silver dragons? And was the threat from Artha and Takhisis truly over?

TODAY

"Dragon Magic" begins in the early summer of the year 354 in the Age of Dragons, about two years after the end of the War of the Lance and about a month after the events of the first module in this series, "In Search of Dragons."

Though peace has come at last, the world is far from serene. While the forces of good struggle to rebuild, the forces of evil continue their stranglehold on much of the land.

DM'S BACKGROUND

In the beginning, the gods created good, evil, and neutrality. Conflict among the gods resulted in the All-Saints War, resolved when the good and neutral gods combined forces to prevent evil from claiming victory. Good, evil, and neutrality persist to this day. Their balance is crucial to the harmony of all things.

As the embodiment of elemental forces, the development of good, evil, and neutral dragons paralleled this balance. Just as the neutral gods joined forces with good in the All-Saints War, the neutral dragons at one time aligned with the good dragons as a defensive measure against the evil dragons. The relationship between good and neutral dragons remains strong—it is a bond from which they both benefit.

The personification of neutrality in dragons is the Astral Dragon, an entity which has existed since the beginning of time and to which all dragons—good, evil, and neutral alike—can trace a common ancestry.

The Astral Dragon resides in a magnificent palace in the dragons' ancestral home, on another plane of existence. Evil dragons have been banished from this plane. Because the Astral Dragon believes that neutrality must be strictly observed in order to maintain balance in the multiverse, good dragons are also discouraged from visiting her plane.

However, because of the honorable relationship between good and neutral, the good dragons have a special portal which gives them access to their ancestral home and to the palace of the Astral Dragon. Though the good dragons refrain from using the portal—to do so would violate the wishes of the Astral Dragon—the mere existence of the portal is a source of security and strength for the good dragons. Therefore, the location of this portal, the only known pathway to the dragons' ancestral home and the palace of the Astral Dragon, is the most closely guarded secret of the good dragons.

Takhisis has long believed that the plane of the Astral Dragon is a vulnerable point for the forces of good. If the Astral Dragon could be eliminated, believes Takhisis, the bond between good and neutral would likewise disappear and evil would be able to subdue good. After all, it required the combined forces of good and neutral to defeat evil in the All-Saints War.

Takhisis, unable to discover the location of the secret portal, has long suspected it exists somewhere in Cirulon, a city in the clouds belonging to the good dragons. (Takhisis is wrong—the portal is not in Cirulon.) Cirulon is normally impenetrable to the forces of evil, but the blending ceremonies of Artha and Khardra have weakened its wards. For months, evil minions have been assaulting Cirulon. Though much of Cirulon has been destroyed, the secret portal has not yet been found. Still, the assaults against Cirulon continue, led by a recently returned and newly determined Artha, who is beginning to share Takhisis's lust for control of all creation.

PROLOGUE: EARS OF CORN



DM'S BACKGROUND

Eons ago, the gods of good presented to their dragon faithful the gift of Cirulon, a fabulous city in the clouds. The good dragons used the city as a refuge and stronghold, as well as a repository for some of their most valuable treasures. An aura of light which enveloped the city created an impervious barrier against the forces of evil and provided privacy and safety for Cirulon's residents.

However, the blending ceremonies of Artha and Khardra that caused the moons and stars to fade also weakened Cirulon's defensive aura. Takhisis saw this as an opportunity to assault the city, which she long suspected housed the secret portal to the plane of the Astral Dragon. Under Artha's direction, evil minions began a steady assault on Cirulon and were able to breach the city's wards for the first time in history, destroying much of Cirulon in the process.

The Council of Cirulon, a legislative body composed of ancient dragons of each good color, summoned the good dragons of Krynn to help defend the city. But weakened by the fading moons, the good dragons were barely able to hold their own against the powerful forces of evil rallied by Artha. The casualties for the good dragons mounted while their city crumbled around them.

Though the secret portal was not, in fact, located in Cirulon, the Council became increasingly concerned about an assault against the Astral Dragon if Artha somehow managed to find a way to her plane. The Council sent an emissary to the Astral Dragon, requesting permission to garrison her plane with good dragons, against a possible assault. Permission was denied; the Astral Dragon saw no need to violate

what she held as a sacred principle of neutrality. However, she sent an emissary of her own named Abriele back to Cirulon to represent her on the Council and monitor the situation.

A few weeks ago, it appeared that the fortunes of Cirulon were changing. Thanks to the efforts of a conclave of good dragons and a courageous band of Krynn companions, Artha and Khardra were defeated. With their defeat, the fading of the moons stopped. And when the fading stopped, the protective aura of Cirulon began to grow stronger. The Council presumed it was now just a matter of time before the evil forces gave up the search for the portal and withdrew.

But thanks to information from an unusual source, the Council recently learned the threat to their city may not yet be over.

A few days ago, the spirit of a silver dragon named Saramber appeared in the Council Chambers to convince the Council that the problems of the good dragons stemmed not only from the fading moons, but also from the violation of an ancient bond between good dragons and the good folk of Krynn. Saramber explained that it had taken good dragons and good people working together in an atmosphere of trust and respect to bring about the defeat of Artha and Khardra.

The dragon spirit had recently experienced a vivid premonition of Cirulon exploding in a ball of flame, attacked by a mysterious dark tower. She claimed that the attack would occur very soon, and that without the help of good people, the good dragons would be unable to defend themselves.

Though some of the Council members were inclined to believe Saramber, others rejected her premonition as nonsense. Why should good dragons trust the people of Krynn now? After all, it was the people of Krynn who had rejected





and exploited the dragons, not the other way around. And what could a man possibly do to save Cirulon that a dragon couldn't? Saramber admitted that her premonition had not revealed exactly what the good people could do to help, nor had it revealed the details of this devastating attack. But she remained convinced that without the help of good people, the city faced destruction.

After a prolonged argument, the dragons turned to Abriele, the emissary of the Astral Dragon, for her opinion. Abriele agreed that it seemed reasonable to include good people in the defense of Cirulon; after all, there seemed to be little to lose at this point. But Abriele strongly cautioned against violating the balance of good, evil, and neutrality. "I cannot allow excessive tampering with the natural balance," she said. "There are principles more sacred than this city."

Ultimately, the Council gave Saramber permission to journey to Krynn and select a group of good people to help with the defense of Cirulon. Abriele would accompany her to advise, observe, and ensure that the principles she represented were not violated.

GETTING STARTED

The PCs begin the adventure in any small village of your choice, so long as it is peaceful and a good distance from any major city. This village could be any of the PCs' hometowns in northern Estwilde or any other friendly village from the first adventure, such as Ohme or Belleria. If you have trouble deciding, begin in Fair Meadows with the party turning in for a good night's sleep at the village's only hostelry, the Shaggy Goat Inn.

What brought the PCs to this village is up to you—they could be visiting relatives or friends, they could be gathering for a reunion, or they could be en route to a hunting lodge or a business meeting.

It has been 28 days since the end of the first adventure.

PLAYERS' INTRODUCTION

The adventure begins as the PCs are snuggled under their blankets for a good night's rest. Read whichever of the following boxed texts is appropriate to your party. If the party consists of old and new PCs, read the appropriate text to each.

The texts represent the last of the day's thoughts before drifting to sleep.

If the PCs successfully completed the first adventure:

It has been a difficult but rewarding month. Following your victory at the Peak of Clouds, you have spent your days traveling from village to village, assisting in the recovery of the lands left devastated by the War of the Lance. Though there is much left to do, there are encouraging signs of progress—new crops in the fields, new homes rising from the rubble, new hope in the eyes of your fellow countrymen.

Still, a sense of unease hangs heavy over the land. Is it because the Dragonarmies still control large sections of the continent? Because a new war may be just a sword slash away? Or because the good dragons, who seem so important to Krynn, are still nowhere to be found?

And what of the final words spoken to you and your companions by the dragon on the Peak of Clouds before he ascended into the sky on that incredible crystal stairway? "You will hear from us soon," he promised. "Our problems are not yet over." What could he have meant?

If the PCs participated in the previous adventure, but failed to stop Artha and Khardra:

Weary from a long day, your body aches for rest. But there is no reason to believe this night will be any more restful than the others. As it has for weeks, the confrontation on the Peak of Clouds with the loathsome Artha and Khardra continues to haunt you. Your best efforts were in vain, and the price of defeat was high—the death of your draconic allies and the continuation of Artha and Khardra's campaign of evil.

At least there's some comfort in hearing that a cadre of good dragons tracked down and defeated Artha and Khardra, thus ending the threat of the fading moons. Still, you can't help but wonder how many additional lives would have been spared had you succeeded in your efforts on the Peak of Clouds.

If only the gods granted second chances.

If the PCs did not participate in the previous adventure:

It has been over two years since the War of the Lance ended, and those left devastated by the conflict continue to struggle for recovery. Though there is much left to do, there are encouraging signs of progress—new crops in the fields, new homes rising from the rubble, new hope in the eyes of your countrymen.

Even so, a sense of unease hangs heavy over the land. The forces of evil still control large sections of the continent. Many feel a new war may be just a sword thrust away.

But most troubling of all has been the mysterious disappearance of good dragons. In the months following the War of the Lance, dragon sightings have grown increasingly rare. Since the good dragons of Krynn seem so important to the fate of Krynn, there is genuine cause for concern.

There has been no shortage of rumors as to the reason for their disappearance. Some say that the dragons have abandoned Krynn as they did centuries ago. Others believe that the dragons are dying from a mysterious disease as a punishment from the gods. Still others wonder if perhaps Krynn's citizens became too exploitive of the good dragons since the war's end. Regardless of the reason, the absence of good dragons does not bode well for the future of Krynn.

SILVER DRAGON DREAMS

Once asleep, each PC experiences an identical dream. If anyone stands guard or stays awake for some other reason while his companions rest, he experiences the dream as soon as he goes to sleep.

The source of the dream is the spirit of Saramber, a young silver dragon who aided the characters in the first adventure and died of a mysterious disease that is killing the silver dragons of Krynn. She has come to recruit help for the defense of Cirulon as directed by her premonition.

If the PCs participated in the first adventure, Saramber was impressed with their courage and has come to ask for their help again. If they did not participate in that adventure, she has chosen them because she senses they have the courage and trustworthiness necessary for her mission.

The dream is experienced in two parts. The end of the first part blends into the beginning of the second. In spite of the disturbing nature of some of the images, no one wakes until the dream ends.

I. DREAMS FROM THE PAST

A beautiful young woman beckons to you from a swirling silver mist. She has waist-length black hair and wears a billowing silk gown. Her fair skin is covered with purple stains. Then her form shimmers, and streams of brilliant light flash from her body.

"I come for your help," she says softly, "to confront a menace that threatens to destroy us all."

This is the spirit of Saramber, appearing in her human form. The stains on her body are a symptom of the disease that killed her. If the PCs encountered Saramber in the first adventure, she looks like she did the first time they met.

She continues. "Only by drawing on the bond between us can there be hope for our world—the sacred bond that has bound good dragons and good people since time began, a bond based on trust, respect, and cooperation.

"When this bond is threatened by doubt, disrespect, and disharmony, all suffer."

The image of Saramber fades and is replaced by the following sequence of images; the end of one dissolves into the beginning of the next. The images are accompanied by the sound of a distant, howling wind. (These images are based on events in the first adventure.)

—A sobbing female dwarf dressed in rags sifts through the rubble of a demolished village. She uncovers the body of a male dwarf and clutches him to her chest.

—A band of laughing ogres attacks an ancient bronze dragon who appears helpless to defend himself. Some gleefully beat the dragon with clubs while others carry armloads of treasure from his cave.

—Flames engulf a large horse ranch. Desperate figures struggle in vain to put out the fires. Corpses of men and horses litter the ground.

—A family of silver dragons lies dead in a grassy meadow, their bodies covered with purple stains and bruises.

With the image of the dead silver dragons, Saramber speaks again. "But when the bond between us is strong, we flourish and prevail."

The dead dragons fade and are replaced by the following sequence of images; the end of one dissolves into the beginning of the next. The distant, howling wind continues. (These images are scenes from the climactic battle with Artha and Khardra from the previous adventure. If the PCs participated in that adventure, describe the images in such a way that the PCs recognize themselves and their companions.)

—Mighty warriors astride gold and bronze dragons battle against riderless black dragons above what appears to be a mountain plateau surrounded by high cliffs.

—The same scene, from a greater distance. The battle now rages nearer the cliffs. Two black dragons lie dead in the dust. The other black dragons appear to be losing to the good dragons and their riders. In the center of the plateau, a tall humanoid creature with greenish-gray skin covered with jagged scars clutches an obese woman shrouded in dark fog and draped in shreds of black silk. Bright light streams from their bodies.

—A gold dragon holds the humanoid creature in its jaws. The humanoid explodes.

—An immense five-headed dragon appears in the clouds. The obese woman stretches unnaturally, then splits into five pieces. Each piece is swept into the mouth of a dragon head.

With this final image, Saramber speaks again.

"That is the past. Now look to the future."

2. DREAMS OF THE FUTURE

Your eyes open and the air shimmers around you, blurring the images of your familiar surroundings. A moment later, you are hovering high in the night sky, hundreds of miles over the surface of Krynn. The cool air chills your body while a thousand stars twinkle above you in the darkness. You cannot move or speak. The silence is broken only by the howl of a distant wind.

This is a continuation of the dream, although the images are so vivid the PCs may believe they are awake. Do not confirm or deny this, but make it clear they are unable to speak, move, or take any other actions. As before, each PC experiences an identical dream.

The starry sky fades and is replaced by the following sequence of images; the end of one dissolves into the beginning of the next. The images are still accompanied by the distant, howling wind.

—The PC is floating high above a magnificent city nestled in a bank of fleecy clouds. The city consists of many huge buildings and massive domes, though the features of the structures are indistinct. There are no signs of life.

—The same image, but a black tower is approaching the city from the north. The features of the tower are indistinct.

—The tower, now hovering over the city, bursts into a massive fireball. The city is lost in a sea of flame. Buildings crumble soundlessly as tongues of fire stretch high into the sky, licking (harmlessly) about the characters' bodies.

—The PC stands in the middle of his hometown's main street on a beautiful summer's day. Citizens go about their business, oblivious to his presence.

—The same image, but an airborne black tower floats toward the village from the north. The features of the tower are indistinct.

—The tower bursts into flames. Citizens panic, racing soundlessly through the streets as buildings crumble around them. The flames spread quickly, enveloping the village in a sea of fire.

—The PC is back in his room (or wherever he originally went to bed). Everything is as it was before. Wisps of mist rise from the foot of his bed. Within the shimmering mist the beautiful girl appears once more. Her image ripples, then is replaced by a large silver dragon. The dragon's skin is covered, as she was, with purple stains.

This was Saramber's natural form. She speaks in the same soft voice previously used by the girl.

"If our bond remains strong, good dragons and good people will triumph. Will you help us?"

Saramber lifts the veil of sleep just enough that they can answer this question by nodding their heads, yes or no. If they answer no or refuse to answer, see "Troubleshooting" at the end of this chapter.

Presuming the PCs agree to help, Saramber continues. "If you have questions, I ask for your patience. All will be answered in time. Tomorrow at dusk, gather in the meadow of violets two miles north of here. Bring whatever you need for a long trip.

"Now sleep."

PREPARATION DAY

The PCs awaken the next day, refreshed and invigorated. All remember last night's dream in vivid detail. If they share their dreams with each other, they should realize that all experienced identical dreams.



Citizens of the village are too preoccupied with their own problems to offer much help to the PCs. The PCs will not be able to recruit anyone to accompany them, nor will anyone be able to interpret their dreams for them. If the PCs indicate their dreams had something to do with dragons, the citizens will be especially reluctant to help, as mistrust of dragons still lingers in the minds of most.

It is up to the PCs to decide what Saramber meant by "a long trip" and prepare accordingly. All items in the *Players Handbook* Equipment Lists are available for purchase in the village at the prices given (converted to the DRAGONLANCE® game steel standard). No magical items are available.

Any PC born and raised in this village knows of the meadow of violets indicated by Saramber, as the meadow has long been a favorite rendezvous for romantic teenagers. Otherwise, any local can direct them. If the party is a mix of both males and females, their request for this information is likely to be met with a knowing smirk.

THE MEADOW OF VIOLETS

The journey to the meadow of violets is uneventful, a pleasant trip on a seldom-used dirt road lined with wheat fields and apple orchards. After traveling about two miles, the party approaches a meadow surrounded by tall oak trees and filled with purple violets.

As the party enters the meadow, a teenage boy and girl rise from within a clump of taller grass, hurriedly brushing themselves off.

Andru and **Cinda** are teenage lovebirds who came to the meadow to cuddle. Jumping guiltily to silly conclusions, they assume this travel-laden party has been sent to find them.

If the PCs let them go, Andru and Cinda vanish into the forest and sneak back home. If the PCs wish to question them, the teenagers make no attempt to flee.

If questioned, Andru and Cinda cower and make stumbling excuses as to what they were doing in the meadow. "We were watching birds build nests," says Andru. Cinda jabs him with her elbow. "No we weren't," she whispers. "Not in the grass, stupid." While Andru and Cinda sort out their stories, the PCs can attempt to reassure them that they weren't sent by their parents and don't care what they were doing. Once reassured, Andru and Cinda talk freely with the party.

Unfortunately, neither Andru nor Cinda have much information to share. However, if the PCs ask about anything suspicious they might have seen, Andru mentions "A great big bat, with a big belly. It just appeared out of nowhere while we were...uh, looking for bird nests." The bat sniffed them, then disappeared. He didn't see where it went.

If the PCs give them permission to stay, Andru and Cinda decline, saying they were just on their way home. "See those clouds?" says Cinda. "It's going to rain." Sure enough, a pocket of dark clouds is gathering overhead. Less than an hour ago, the sky was cloudless.

When the PCs finish asking any questions, Andru and Cinda say goodbye and head back to the village, holding hands when they think they're out of sight.

STRANGE ENCOUNTER

FIRST MEETING

The sun sets, and time passes. There is no sign of Saramber. Thanks to the dark clouds in the sky, the area is soon pitch dark. If the PCs thought to bring torches or lanterns, they may use them for light.

After about two hours of game time have passed, ask each PC what he or she is doing. Choose one to experience the following encounter. This PC should be a character who is apart from the rest of the group, perhaps to check the road, polish a weapon, or prepare a meal.

You are startled by a thin, reedy voice behind you. "Hold still. Please don't move."

You turn your head to see a strange creature hovering at eye level. "Hold still," it says again. The creature resembles a dragon about the size of a house cat, but instead of scales, fine gray fur covers it from head to toe. It has leathery wings, a blunted snout, spindly arms and legs, and huge bulging, black eyes. It is using a stylus to engrave intricate symbols in a thick, red tablet. It rapidly glances back and forth between you and the tablet, the engraving instrument moving deftly in its hand.

This is **Abriele**, the representative of the Astral Dragon sent to monitor the situation on Cirulon and accompany Saramber (see Chapter 1). Pick some unusual feature of this PC's appearance or dress, possibly something about which the character is embarrassed. This is the first time Abriele has ever seen such a feature close-up, and she is creating a bas-relief portrait of the PC to mark the occasion.

ABOUT ABRIELE

Abriele is a kodragon, an extremely rare species of dragon that makes its home only in the plane of the Astral Dragon. While kodragons retain most of the characteristics of dragons, other characteristics are similar to those of mammals. Most notable among these are their fine fur (which they groom continually, like a cat), a magical pouch on their belly (which functions similarly to a *bag of holding*), and opposable thumbs which allow for the manipulation of tools.

Abriele, like all kodragons, rarely uses tools or weapons, but she is a meticulous record-keeper with a remarkable aptitude for art. She creates bas-relief sculptures by carving clay-like square tablets with a stylus. These materials are kept in her pouch. Her art works are not for recreation, but are created as records of her observations.

Abriele is of neutral alignment, but she has tendencies toward good that she struggles to repress. She is patient, intelligent, and somewhat arrogant.

As a representative of the Astral Dragon, she has a store of gifts in her pouch, favors to be bestowed in the name of her Mistress upon appropriate recipients. She rarely finds anyone whom she deems worthy to receive one of these favors.

Talking with Abriele can be extremely frustrating, as she is usually more interested in analyzing motives than in answering questions. For example, if someone asks where she comes from, she will respond, "Why do you want to know?" Regardless of the answer, Abriele says, "I see." She makes a few symbols on her tablet, then considers the matter dropped. If the question is repeated, she responds the same way. The cycle continues as long as the questioner can stand it.

Abriele will not reveal any details about herself or her mission. Additionally, she has a secret from even the good dragons: a month-old baby, kept safely in her pouch, out of sight.

Abriele always avoids combat, responding to attacks with her claws and beak only until she can *teleport* out. She also uses her *shrinking gas* breath weapon as necessary. She is likely to use *teleport without error* and *plane shift* to escape trouble.

ABRIELE DECIDES

If the PC who first meets Abriele attacks or threatens her in any way, she *teleports* to safety, reappearing nearby a few moments later. Abriele, of course, takes no hostile actions toward the PC. Instead, she studies him curiously, engraving a few symbols on another of her thick, red tablets to record the event.

She reveals her name if asked, but responds with the “Why do you ask?” routine described above to any other questions. She will also show her tablet-sculpture if asked, though she will not explain it. If the PC succeeds in a Wisdom Check, he recognizes it as an abstract portrait of himself, rendered as an arrangement of geometric symbols. If he fails the Wisdom Check, it just looks like a mess of lumps and scribbles.

If the PC summons his companions, Abriele hovers just overhead, etching furiously on a tablet to record the event. If the PC does not summon his companions, Abriele flies to them, then hovers overhead and etches furiously. She responds to any questions as she did with the chosen PC, likewise *teleporting* away if things get hostile. As before, she will show them their portrait if asked; the PCs recognize the subjects of the portrait if they succeed in Wisdom Checks.

When Abriele has finished her etching, she puts the tablet and stylus in her pouch. “You have my permission to attempt to help Cirulon, the cloud city of the good dragons,” she says. “Follow me.”

Abriele begins to flap slowly toward a range of hills to the north. She stays about six feet from the ground so the PCs don’t lose sight of her. If they hesitate, she waits patiently. As before, she answers no questions directly, relying on her “Why do you ask?” routine as necessary.

STAIRWAY TO THE SKY

Abriele leads the party through the forest toward a crest about a mile away. If asked about their destination, Abriele says, “Follow me.” If asked anything else, she responds with her “Why do you ask?” routine.

As the party approaches the foothills, Abriele stops. “Wait,” she says. She cocks her head and listens, then disappears. Five minutes pass. Abriele reappears in the same spot. “Continue. Follow me.” (Abriele’s baby was distressed, so she *plane shifted* away to attend to her. Once assured that the baby was fine, Abriele *plane shifted* back. She won’t say anything about her disappearance.)

Abriele leads the party up a winding path. They round a sharp curve to find a blockade of two huge trees which collapsed across the path, the result of a recent windstorm. Thick tangles of branches extend from the 6-foot-diameter trunks. A detour looks like the best solution.

However, before the PCs reach a decision, Abriele says, “Stand clear.” She then blasts the trees with her breath weapon, causing them to *shrink*, though they appear to vanish. “Follow me,” she says, matter-of-factly continuing along the path.

If anyone examines the area to either side of the path, he finds an uprooted tree, about eighteen inches tall, in exactly the same proportion as the tree that had been blocking the path to that side. Helpful as always, Abriele neither confirms nor denies the effect of her breath weapon.

The path leads to the top of the highest hill overlooking the meadow and the entire forest. In the distance, the PCs can see the flickering lights of the village.

Once the party reaches the top of the hill, Abriele stops, then glides to the ground. A few yards away, the air shimmers, and wisps of mist rise from ground. The hazy image of a silver dragon covered with purple stains appears inside the

mist. Streams of light radiate from her body. This is the image of Saramber; the party immediately recognizes her as the dragon who appeared in their dreams.

“Welcome,” says Saramber, then raises her head toward the heavens. She begins a low roar that crescendos until the earth shakes. The sky shimmers, and a sparkling crystal stairway appears, leading from the top of the hill out of sight into the sky.

“Come,” says Saramber, beckoning to the stairway. Hovering a few feet from the ground, Abriele leads the way up the stairs. “Continue. Follow me.”

The PCs may bring all of their gear, with the exception of horses or any other pack animals. “Your mounts must stay. We cannot allow innocent animals to be endangered.” They are adamant about this.

If the PCs have any questions for Saramber, she says, “Please be patient. All will be answered in time.” Abriele responds to most questions with her “Why do you ask?” routine; if they ask her about their destination, she says simply, “Follow me.”

The steps are spongy and slightly warm. Each step the PCs take advances them a great distance up the stairway—whether it is a hundred yards or several miles is difficult to determine. The stairway vanishes behind them as they climb.

Saramber floats alongside the PCs; no matter how far each step takes them, she stays nearby. Abriele continues to lead the way.

THE DRAGONS’ TESTS

SARAMBER’S PACT

When the Council of Cirulon agreed to allow Saramber to recruit good people to help defend their city, Saramber said the recruits should be given gifts from those items for which Abriele was responsible, to help them with their mission. Abriele vetoed the idea, saying the extra help would violate the sacred balance of good and neutrality. Saramber argued that without the gifts, her recruits would be doomed—they would be fighting in an unfamiliar environment against enemies they had probably never encountered before. Abriele was unmoved.

So Saramber offered another idea. “In spite of my intentions, I cannot be certain the people I choose are truly good,” she said to Abriele. “Would it not be in the best interests of the balance you speak of to assure ourselves of their goodness before bringing them to Cirulon?” Abriele agreed that it would.

Saramber proposed that she and Abriele devise a series of brief tests for her recruits and observe their behavior. “And if they are to be subjected to these ordeals,” Saramber added, “their efforts should be rewarded to maintain the integrity of the balance.” Abriele thought this over, then agreed. If the recruits underwent the tests, they might receive a favor or two.

ABOUT THE TESTS

All of the settings for the tests are actually powerful dreams created by Abriele and the spirit of Saramber. When a dream is triggered, as described below, the PCs freeze on the stairway while the dreams play out in their minds. They remain sufficiently conscious to think and act in the dreams.

Thus they can use their equipment (including weapons), speak with each other, cast spells, and take any other normal actions. However, they cannot leave the dream, even by casting *dispel magic* or similar spells.

After each dream test, Abriele and Saramber will evaluate



their performance. The PCs can enter into these discussions; they should quickly figure out that they are being evaluated for their good qualities, although Saramber and Abriele will not acknowledge this.

Saramber rewards the PCs after they experience the third dream. After each dream, note the PCs' actions and their defense of these actions to Saramber and Abriele. Details for evaluating the party's performance are given in "Rewards", below.

JEWEL ORCHARD

You are suddenly standing in a grassy meadow with the sun shining brightly overhead and a cool breeze caressing your skin. You are just outside a wooden fence about four feet high. The fence encloses an orchard with hundreds of leafy trees. Rubies the size of apples hang from their branches. There are no other signs of life.

This dream tests the party's honesty. The fence is intended to show that the gems belong to someone. The PCs can easily step over the fence to take a ruby if they like. There is no one to stop them and nothing else in the area.

After a PC takes a ruby, the dream ends in a minute or two. Likewise, if the PCs make no attempt to take a gem within five minutes, the dream ends.

When the dream ends, the PCs abruptly find themselves back on the crystal stairway. If they refrained from taking a ruby, Saramber congratulates them on their honesty; neither dragon will discuss the dream further.

If the PCs took a ruby, Abriele matter-of-factly speaks to Saramber. "They took something that did not belong to them. That demonstrates dishonesty, which is not representative of a good person." Saramber asks the PCs to explain their actions. If they tell an obvious lie ("We thought they were real apples."), Abriele says to Saramber, "Further proof of my analysis." If they give a reasonable excuse ("We thought this might be evidence of an evil wizard and merely wished to examine it."), Abriele accepts it. She is not stupid—if the PCs were greedily stuffing rubies into their pockets, no excuse will suffice.

Everyone continues up the stairs. The next dream occurs a few minutes later.

"MERCY" KILLING

The fabric of the starry sky above you begins to rip. A gigantic bony hand extends from the rip, reaching down to enfold you in a gray void. When you are next aware of your surroundings, you are standing on a steel platform hovering about 50 yards above a huge covered pen. The pen contains dozens of listless silver dragons, each with at least one purple stain. The only movements any of the dragons make are occasional restless stirrings.

Each of you holds a steel rod nearly 10 feet long. The rod's end has a reddish glow and is warm in your hands.

A deep voice thunders from the clouds above. "Put them out of their misery. They have no hope against this dread disease. Kill them all."

This dream tests the party's compassion. The PCs can experiment with the rods by pointing them into the sky and concentrating; thick jets of flame roar from the rods, and the pens are easily within the rods' range.

If the PCs address the voice in the clouds, it just repeats the

same instructions. The dragons do not respond to the PCs.

If the PCs blast flames at the dragons, the dream ends. If the PCs refuse to blast flames at the dragons for five minutes, the dream ends.

When the dream ends, the PCs abruptly find themselves back on the crystal stairway. If the PCs refrained from flaming the dragons, Saramber congratulates them on their compassion; neither dragon will discuss the dream further. If the PCs flamed the dragons, Abriele speaks matter-of-factly to Saramber. "They obeyed anonymous instructions to kill. That demonstrates brutality, which is not representative of a good person." Saramber asks the PCs to explain their actions. If they tell an obvious lie ("The rods went off by accident."), Abriele says to Saramber, "Further proof of my analysis." If they give a reasonable excuse ("We believed we were hearing the voice of our god."), Abriele accepts it.

The party continues up the stairs. They experience the next dream a few minutes later.

CAVE BATTLE

You begin to sink into the stairway as if it were quicksand. About a minute after your heads are covered over, you find yourselves standing in a foot of water at the back of a dark cave. The cave is about 25 yards in diameter with a single 10-yard-wide exit leading to the open sea. The sides of the cave are slick with algae, making them impossible to climb.

A monstrous **giant octopus** bursts through the surface of the water at the entrance to the cave, waving its tentacles menacingly. One of the tentacles is coiled around a shrieking **boy**.

This dream tests the party's courage. The octopus attacks the PCs with its free tentacles, snapping with its beak at any PC within reach.

Though this is a dream, conduct normal combat and assess damage to both the PCs and the octopus. Neither confirm nor deny any PC's suspicions that the combat isn't real.

If the boy or octopus is killed, the dream ends. If the PCs refuse to fight, the dream ends. If a PC "dies" or half of the PCs lose at least half of their hit points, the dream ends.

When the dream ends, the PCs abruptly find themselves back on the crystal stairway, completely unharmed. If the PCs fought the octopus and attempted to rescue the boy, regardless of the outcome, Saramber congratulates them for their courage; neither dragon will discuss the dream further. If the PCs refused to fight for any reason, Abriele speaks matter-of-factly to Saramber. "They declined to save the child. That demonstrates cowardice, which is not representative of a good person." Saramber asks the PCs to explain their actions. This time, it will be difficult for the PCs to justify themselves; refusing to fight because they suspected the octopus wasn't real is an unacceptable excuse as far as Abriele is concerned.

REWARDS

After the final dream, the PCs find themselves back on the stairs once more with Saramber and Abriele, who are ready to reward them. "Your patience for enduring our tests is appreciated," says Saramber. "Before you enter Cirulon, we wish to reward you for your efforts."

Be generous in awarding these gifts. If the PCs made a reasonable effort in all three dreams, award them all four gifts; even if they performed an inappropriate action (such as stealing the rubies), give them credit for it if they made a sincere

argument to Abriele or if they apologized for failing (humility is also a quality of goodness). If they disastrously failed in one of the dreams, award only the first three gifts. If they failed in two, award only the first two gifts. They receive only the information from Saramber (number 1) if they failed in all three dreams.

Saramber describes each gift as Abriele presents it to the PCs. By agreement with Abriele, her descriptions are necessarily vague.

The gifts:

1. A bank of mist rolls up beside the stairway. An immense tube appears beside the stairs, stretching out of sight into the mist in either direction. There is a dark blue circular indentation about 100 feet in diameter on the side of the tube facing the PCs. "The key to the doors is faith," says Saramber. "To enter, you need only walk through." (This is a gift of knowledge regarding use of the doorways in Cirulon—more about this in Chapter 1.)

2. A pair of tiny silver dragon wings appears in each PC's hand. "For empathy and access," says Saramber mysteriously. "Find their use in the city." (These are magical items called *dragon wings*. The *dragon wings* are useless without the help of an appropriate silver dragon—their effects are explained in Chapter 1.)

3. A *staff of curing* appears in the hands of the PC who is most often concerned with healing others. "For healing," says Saramber. (The *staff of curing* has 20 charges, is useable by anyone of good alignment, and works on anyone of good alignment, dragons as well as people. It heals 1d8 hits, once per day per subject.)

4. A bank of mist rolls up beside the stairway. A 16-foot lance with a silver glow appears within the mist. "To help vanquish our enemies," says Saramber. (This is a mounted *dragonlance*, but it is only an image; Saramber is telling the PCs the weapon is available in Cirulon—more about this in Chapter 1.)

With the presentation of the gifts, Saramber begins to fade. "Farewell, my friends," she says. "When you reach the end of the stairs, rest for the night. You will have access to Cirulon at dawn." She vanishes in a flash of light. Abriele stares at the PCs, looks as if she's about to speak, then thinks better of it. She disappears abruptly, having *plane shifted* away.

The PCs may continue up the stairs.

A FINAL GIFT

As the PCs near a cloud bank at the end of the stairway, Abriele reappears in front of them. Again, she starts to speak, then stops short. Muttering, she reaches into her pouch and produces a leather bag that she gives to the nearest PC. "For a later time," she says, then *plane shifts* away once more.

Inside the bag are two ears of mouldy black corn, wrapped in mouldy gray husks. They are obviously inedible. (Temporarily succumbing to her good tendencies, Abriele left this gift with the PCs, though she couldn't bring herself to tell them why they'd need them. The ears are a clue to a puzzle in Chapter 3.)

END OF THE STAIRWAY

The crystal stairway ends in a bank of fleecy clouds. Swirling fog envelops the cloud bank, making it impossible to see further. If the PCs dispel the fog by magical or other means, they see a gigantic bank of clouds a hundred yards away. If the PCs attempt to reach the gigantic cloud bank by *flying* or similar spells, they find the cloud bank always remains a hundred yards distant.

The cloud bank the PCs are on has the texture of cotton, an inviting surface on which to sleep.

At dawn, a strong wind rises, and the fog swirls madly. When the last of the fog has finally dissipated, the PCs see a crystal bridge leading from their cloud bank to the gigantic cloud bank about a hundred yards away. The bridge ends at what appears to be an entrance—two gleaming columns tower into the sky, beyond which lies a city of immense buildings and domes, sparkling in the sunlight, half-hidden by swirling wisps of fog.

TROUBLESHOOTING

Here are some tips for handling unexpected problems:

If the PCs refuse to go to the meadow of violets, if they refuse to go up the crystal stairs, or if they otherwise drag their feet. The spirit of Saramber causes the reluctant PCs to re-experience the original dream of the destruction of the cloud city and their home villages. If they still aren't sufficiently motivated, increase the stakes by adding images of the violent deaths of their friends and families to the dream.

If the PCs blow the dream tests. If they fail because of well-meaning ineptitude (such as by testing the rods in the direction of the silver dragons and accidentally flaming them), consider running another set of tests to give them a second chance. (For instance, they could dream of discovering a unicorn with a broken leg—will they save it or shoot it?)

If the PCs consistently go against their good alignment during the tests—as by gleefully stealing the jewels or making a game of executing the silver dragons—consider thoroughly reviewing the DRAGONLANCE® game principles with them.



CHAPTER I: CITY OF CLOUDS



DM'S OVERVIEW

This chapter begins immediately after the Prologue. Use the large color insert map for reference. In this chapter, the PCs should:

- explore the remnants of the cloud city of Cirulon and sample the dragons' culture and history,
- meet Terrilyn and Kerrija, the silver dragon siblings,
- learn that the assault on Cirulon is part of an effort by the forces of evil to learn the location of a mysterious portal, and
- discover that Artha is still alive.

It is unlikely the party will be able to fully explore Cirulon before the final assault. It is extremely unlikely they will be able to make sense out of most of the art works they encounter. They will have an additional opportunity to look over the city and study the art (with some assistance) in Chapter 2.

The rest of this chapter is divided into five sections.

The first, "DM's Background", gives a brief history of Cirulon's role in this latest assault by Artha.

The second section, "Features of the City", is a general description of Cirulon, touching on:

- the draconic art which is so important to it,
- the cloud material of which it is composed,
- those features common to all of its buildings,
- the travel tunnels, debris, and polish pits scattered throughout it,
- the Dark Area which marks its western and northern borders, and
- the strafing pattern executed by evil dragons as they assault it.

The third section describes "Specific Locations" in the city, beginning with the entrance columns (1) and following the number key of the insert map.

The fourth section lists the "Timeline" for this chapter, beginning with the party's entrance into the city at 8 in the morning, and continuing until the black tower appears fourteen hours later. It also lists some "Random Encounters" that you might want to add to the day's excitement.

As the party makes its way around Cirulon, you'll need to keep your eye on both of these last two sections.

The final section contains the usual "Troubleshooting" hints.

DM'S BACKGROUND

When Cirulon's protective aura was weakened as a result of Khardra and Artha's blending ceremonies, the city became vulnerable to assaults from Artha's evil minions as they searched for the portal to the Astral Dragon's dimension. The minions were promised their choice of slaves, treasure, or power if they discovered the secret portal (a promise Artha has no intention of keeping). Though most of the minions have been killed, a few still roam the city and are likely to be encountered by the PCs.

Artha's search for the portal has so far been in vain; she is beginning to believe that perhaps the portal isn't located in Cirulon after all. (It isn't.) Artha plans a final assault against Cirulon tonight. If the portal isn't found this time, she plans to destroy the rest of the city.

More than two-thirds of Cirulon has already been destroyed by the assaults. Though the dragons managed to

move many of Cirulon's art works to a safer location (see Chapter 4), many more have been destroyed.

There are few signs of life when the PCs arrive in Cirulon. The majority of the good dragons defending the city have been killed, as have many of the attackers. As corpses and debris are absorbed beneath the surface and generally dissipate within 48 hours, there are also few signs of warfare. Most of the remaining good dragons wait in the strongest buildings for the assaults to end.

The air within Cirulon's weakened wards is still cool and sweet. Gentle winds continually blow through the clouds. There are occasional flickers of lightning and brief sprinkles of rain, but otherwise the weather is pleasant. (This changes during and after strafing runs, as explained below.)

FEATURES OF THE CITY

In all of the following, remember that this is a *dragon* city. Everything here is immense and most of it should seem strange and unfamiliar to the party. Doorsills are just barely surmountable and (for instance) the Black Wall and disk in the History Gallery (14) are usable only if a PC stands at the very edge of the disk and touches the very bottom of the wall.

DRACONIC ART

Dragons have an oral rather than a written tradition. Philosophy, literature, religion, and all other elements of draconic knowledge are passed from generation to generation by word of mouth.

However, dragons do not rely entirely on this oral tradition to preserve their culture. Certain ideas and events are far too important to trust to memory, since they could be lost forever in the event of a war, plague, or some other disaster.

Like other civilizations with a rich culture, the dragons have kept many of the most important elements of their heritage alive by preserving them in art. These art works not only enrich the dragons' lives with their sheer beauty, they also serve as permanent records of important ideas and events.

Dragons believe that an artist imbues his work with part of himself. Through intense study, it is possible to glean the artist's complete interpretation of the event or concept represented by his work. However, this process can be time-consuming and extremely difficult. It is a skill mastered by only the most ancient and wise of dragons.

The art works that successfully preserve draconic culture are among the good dragons' greatest treasures, and have been carefully stored in safe places. For centuries Cirulon, thought to be impenetrable due to its protective ward, has served not only as a refuge for the good dragons, but also as one of the most important repositories for masterpieces of draconic art.

Several buildings in Cirulon are galleries of draconic art containing works of a particular style and theme. Though the dragons have stripped the galleries of most of the art (see Chapter 4), much still remains.

The major works are described, including their underlying themes and possible magical effects on the observer. Each description also includes the message it conveys. The subject or theme of a work is not readily apparent to the observer; in fact, comprehending the full meaning of some work is difficult even for scholarly dragons.

Comprehending draconic art is nearly impossible for non-dragons, such as the PCs. To attempt comprehension, the PC must first study the work for a minimum of 3d10 minutes, then succeed in both a Wisdom Check and an Intelligence Check at a penalty of -12 to each. If both checks are success-

ful, reveal the information in the *Theme* section. Each PC can attempt to comprehend a given work only once. Certain encounters in Cirulon may enhance a person's chance at comprehending draconic art.

Unless otherwise specified, assume that major art works are imbedded in the surface of the building, making theft difficult, if not impossible. Don't directly prevent anyone from stealing "loose" art objects, but be sure they are aware that stealing is hardly the action of a good character. If they persist, consider reviewing basic DRAGONLANCE® game principles with them. (Thefts will be dealt with by the Council of Cirulon in Chapter 2.)

All of the major works in the galleries should be considered priceless. If it becomes necessary to determine the monetary value of a work, roll 2d6 and multiply the result by 10,000 for the approximate value in stl.

THE CLOUDS

Cirulon was sculpted by the gods of good from the material of clouds. All structures in Cirulon are made of a magical cloud material. The various types of cloud material are distinguished by their densities. There are three different densities, each with different properties. Oxygen freely permeates all three.

Density 1. This material composes the "ground" surface of the city. It also gathers in large clumps called puffs, natural features of the Cirulon landscape. The opaque puffs, which resemble white bushes and hedges, make good hiding places.

Density 1 is cool to the touch and has the texture of cotton. A typical character sinks slightly with every step (think of walking through snow), and is slowed to half his normal movement rate. Falling on a Density 1 surface from any height causes no damage; it's like falling on a feather mattress.

Density 2. Many of the buildings and all of the travel tunnels are made of Density 2 material. Density 2 is opaque, cool to the touch, and has the texture of dried leather. Movement rates on Density 2 surfaces are normal.

All Density 2 material has been enchanted with permanent *wall of force* spells. The dimming of the moons, however, has weakened these spells, making them vulnerable to disruption. As a result, many of the Density 2 structures are cracked and crumbling.

Falling on a Density 2 surface causes 1-2 hp of damage per 10 feet fallen.

Density 3. The most important structures of Cirulon, such as the History Gallery (14) and the Council Chambers (21), are made of Density 3 material. Density 3 is opaque, cool to the touch, and has the texture of granite. Movement rates on Density 3 surfaces are normal.

All Density 3 material has been enchanted with permanent *wall of force* spells. The dimming of the moons has had no effect on Density 3 material. Much to the frustration of the forces of evil, these buildings are practically invulnerable.

Falling on a Density 3 surface causes 1d6 hp of damage per 10 feet fallen.

BUILDINGS

Many buildings are supported by columns; their height is indicated on the insert map's side elevations.

Although the interiors are often ornately decorated and furnished, the exteriors of Cirulon buildings are featureless. The sole exceptions are the huge circular doors.

Doorways are circular indentations, usually dark blue, about 100 feet in diameter. They are made of the same mate-





rial as the surrounding surface (Density 2 or 3). A door opens automatically when a character of good alignment approaches within 5 feet. The door remains open for 15 seconds. (Note that if an evil character is pursuing a good character through a door, there may be enough time for the evil character to slip through the door before it closes.)

Red doors only open for specific individuals (such as designated good dragons). Neither *open locks* skills or *knock* or similar spells have any effect on these doors.

None of the buildings have windows. Interior light is provided by permanent *continual light* spells cast on various sections of the walls and ceilings. When dragons wish to bask in the sun, they lie on the rooftops or fly to the special sunning columns towering high over the city.

TRAVEL TUNNELS

Since dragons are solitary by nature, privacy was a primary consideration in the city's design. Generally, dragons travel in Cirulon by air, swooping through an automatic door when they want to enter a building. However, dragons desiring privacy use the travel tunnels.

Travel tunnels are huge tubes of Density 2 material linking the various buildings of Cirulon. Dragons using the tunnels can't be seen, thanks to the tunnels' opaque walls.

All doorways to the travel tunnels are dark blue. Interior light is provided by permanent *continual light* spells cast about every 200 feet. (Fault lines indicated on the map are for the reference of the DM and do not represent an actual feature of the tunnels. Note, too, that some of the tunnels have been partially destroyed in the assaults.)

The leathery texture of the tunnel floors gives adequate traction, even when the tunnel rises or drops abruptly.

DEBRIS PILES

These scattered piles of cloud chunks are debris from former structures demolished in an earlier attack by the evil minions. Debris dissipates within 48 hours. Small chunks may be thrown or used as sling ammunition, but because of their light weight, they do only 1 hp of damage.

POLISH PITS

These pits are filled with fine sand to a depth of 10 feet. Dragons rub themselves here to polish their scales. There is nothing of value in the pits.

DARK AREA

Two-thirds of Cirulon has broken off and been destroyed by the recent assaults, leaving only this decaying remnant. This area is filled with a dark, swirling fog that spirals hundreds of feet into the air; it is very musty and rancid.

Normal vision is reduced to 5 feet in this area. Solid footing extends for only 500 feet (5 hexes) into the darkness; should anyone be foolish enough to step over this edge, he will likely be lost forever.

What happen here depends on whether the party came alone or were led here by the imp (from 8:30 p.m. in the "Timeline").

If the PCs came here alone. Roll 1d6 and consult the following table. The party immediately experiences the indicated encounter. For every half-hour the PCs remain in the Dark Area, roll again.

Roll	Result
1	Choking Fog
2	Homunculous
3-4	Shadow
5-6	No Encounter

Choking Fog. The PCs enter an area of especially rancid fog. Each must make a Constitution Check. Those failing suffer 1d4 hp of damage.

Shadow. The PC nearest the back of the party is attacked by a **Shadow** (choose randomly if more than one PC is in this position). The Shadow fights to the death, but it will not leave the Dark Area.

Homunculous. An 18"-tall cross between a bat, a man, and a lizard lurks here, one of several **homunculi** created by the evil mage Dragh. Unfortunately for this creature and its brothers (Location 17), Dragh died yesterday while assaulting Cirulon. Left with no further instructions, and just beginning to realize that it will soon be dead, the homunculous fights until destroyed, but will not leave the Dark Area.

If the PCs were led here by the imp. The imp tosses the object he stole into the Dark Area, then flies in himself. The PCs have no trouble finding the object, but whoever stoops to pick it up is immediately attacked by a **Shadow**. One round later, a **homunculous** joins the fight. One round later, the imp joins the fight, attacking with his tail. The homunculous and the Shadow fight to the death. If the imp loses more than half his hit points or if the homunculous and Shadow are both killed, the imp flees over the north edge of the Dark Area. Neither of the other monsters will leave the Dark Area.

STRAFING PATTERN

Three times today before her final assault, a force of Artha's draconic minions will make a strafing attack on the city. In each assault, the dragons follow the Strafing Pattern exactly as shown on the map. The dragons fly as fast as they can and swoop low, using their breath weapons to randomly attack points along the Strafing Pattern. The attacks are not directed toward any specific target; these are acts of terrorism intended to intimidate the remaining occupants of the city and, if possible, further weaken the city's defenses.

The attack force consists of 30 black, red, and blue dragons of various ages. At this point, these dragons are somewhat reluctant warriors, feeling that the assault of the city is now a lost cause. Therefore, they will not stop to engage in combat or for any other reason, even if attacked themselves. The good dragons of Cirulon can no longer muster a force of sufficient strength to tackle a force of evil dragons this large; therefore, they stay out of the way during the strafing attacks. (You might need to impress upon your party that attacking a draconic force of this size is tantamount to suicide.)

Each assault is preceded by 10 minutes of darkening sky and the sounds of a howling wind. Alert characters may heed this as a signal to take cover.

SPECIFIC LOCATIONS

ENTRANCE COLUMNS

At 8 in the morning, the PCs may follow the crystal bridge to the gleaming columns marking the entrance to Cirulon. The bridge disappears behind them as they move through the entrance.

Once the PCs have passed through the columns, they will feel the spongy texture of the cloud surface beneath their feet and cool, soothing breezes on their skin. In the distance,

they see the featureless buildings of the city shrouded in fingers of mist.

A shrill voice rises from behind a cloud bank to the right "Now, what about the portal? Speak up! I can't hear you, my friend! Have a hard night, did you?"

If anyone investigates, read the following:

A 10-foot-tall female humanoid with filthy animal hides clinging to her skin stands over the corpse of a silver dragon. The creature's most noteworthy features are her two heads, each brimming with sharp teeth. One head puffs on a fat green cigar while the other taunts the dragon corpse, poking at it with a foot. The corpse is covered with purple stains and deep wounds.

The creature is a **giant two-headed troll**, an evil minion who has been searching for the location of the secret portal at Artha's request. She spent the night tormenting the diseased silver dragon until it finally died. She is now exercising her twisted sense of humor by interrogating the body.

If the PCs approach, one head turns to them and smiles. "Nice morning, isn't it?" she says, then gestures to the body. "Quiet, now. I think he's still sleeping."

While the other head continues to poke and taunt, she addresses a random PC and asks pleasantly, "Now suppose you tell me where that portal is?" The other head finally notices the party, telling the first head, "Shut up. They don't know anything. They're too dumb. The boss said to concentrate on the dragons."

The first head is eager to interrogate the party, but the second head would rather continue brutalizing the corpse. After a short argument, the first head abruptly puts a fist through the other's mouth, ending the argument and rendering the second mouth temporarily useless. She then leaps at the party with her remaining teeth and claws.

If the troll loses half her hit points, she starts to snivel and apologize, saying she was "just having a little fun, you know—no need to take it seriously." But meanwhile, she continues to fight, even if the party backs away for a round. She fights to the death.

The corpse of the diseased dragon is beyond help; *cure disease*, *raise dead*, and similar spells have no effect.

2, 16, 20. SUNNING COLUMNS

This pole rises high into the sky. An immense platform perches on the top.

These platforms are used by the dragons for observation and to bask in the sun. Most of them have been destroyed in the assaults on the city; only three remain.

2 (Southwest Platform). Two **harpies** have recently claimed this platform for a perch. If anyone lingers within 50 feet of the column for more than two minutes, there is a 30% chance the harpies are present and will attack. If the PCs draw attention to themselves (such as by being excessively noisy), this chance increases to 50%.

The harpies attack by swooping from the platform and singing in an attempt to lure their intended victims close. They attempt to charm the PCs by touching them, then attack with their claws and a scavenged weapon; one has a *dagger +1* (1d4 + 1), the other has a bone club (1d6). If one harpy is killed, the survivor flees into the clouds.

3. MATHEMATICS GALLERY

Read the following if anyone enters this building:

This building is a single huge room. Bas relief sculptures line the walls from ceiling to floor. The sculptures are collages of triangles, rectangles, and circles filled with colorful clusters of dots and abstract symbols.

The art works in this gallery represent mathematical concepts, including geometric proofs (such as finding the surface area of a sphere) and alternative counting systems (binary and otherwise). The major works represent more complex ideas.

Mathematics is a lost art among dragons, with modern dragons showing little interest in it. This gallery is mainly frequented by wyrms.

Major Works:

Dome of Shapes. At the western end of the gallery lies a transparent dome about 50 feet across. Dark lines, shadowy angles, and vague shapes drift in and out of each other inside this dome. With every movement of the observer, the shapes pulsate and appear to turn inside out.

The dome acts as a type of *hypnotic pattern*. Anyone staring at the dome must save vs. spells or continue gazing at it for 2d10 minutes. The enchantment is broken if the PC is physically pulled away from the dome by a companion who shields his eyes.

Theme. The dome demonstrates the existence of multiple geometries. In some geometries, for instance, a line is not the shortest distance between two points. In others, many different lines can connect the same two points. In ancient times, dragon mathematicians believed that mastery of these geometries would allow instantaneous travel between the various planes of existence, but this idea was never fully developed.

Wall of light. This sculpture, consisting of dense clusters of dots and symbols, covers the eastern third of the gallery wall and glows softly from a permanent *continual light* spell.

Anyone who studies the sculpture for more than 10 minutes must make a Constitution Check or suffer an intense headache for the next 1d4 hours. All attacks will be made at a penalty of -1 during this time. Any form of magical healing, such as a *potion of healing*, cures the headache.

Theme. This represents the life's work of Bylphian, the most revered of all great wyrm mathematicians, in notation of his own design. Among the thousands of symbols in this sculpture are formulas for determining perfect cube roots, the exact value of pi, and the fundamentals of a symbolic logic system which at one time formed the basis of a gold dragon philosophy (see Location 11).

Golden Floor. An unmarked solid gold platform, about 50 feet square, sits against the southern wall.

Any PC who steps on the platform feels a tingle ripple through his body. If he remains on the platform for two minutes, he must make a Constitution Check. If he fails, he loses 1d4 hp of damage. If he remains on the platform for an additional two minutes, he makes a second Constitution Check, losing another 1d4 hp if he fails.

The platform is a learning aid used by the dragons to temporarily enhance their comprehension by tapping into the collective consciousness of the spirits of dead scholars. If a PC remains on the platform for the full four minutes, make an Intelligence Check. If he succeeds, his Intelligence and Wisdom Check penalty for comprehending draconic art is -9 (rather than -12) for the next 1d6 hours.



4. FOUNTAIN

Clear liquid flows from the five sculpted dragon heads which form this ivory fountain. A stream of liquid trickles from a crack in the base.

This magical fountain has a permanent supply of liquid which acts as a *potion of healing*. If the liquid is not sipped straight from the fountain, it has no magical effect. Anyone can take advantage of the fountain's magical liquid once per day. The crack in the base is the result of the assaults.

5, 8, 18. LIVING QUARTERS

These are living quarters used by the dragons of Cirulon. These three are all that are left; the rest have been destroyed in the assaults. Each consists of a single room lined with Density 1 puffs for nests. All have red doors so only the occupant can gain access; the occupant can provide the necessary code word or other signal (such as a series of taps) to visitors. Since the Council discourages dragons from bringing treasure or other items to Cirulon, these domed quarters have nothing of value.

None of these three are currently occupied except 18, which houses Kerrija and Terrilyn, the silver dragon siblings. The siblings are inside prior to the daily appearance of the rainbow. If the PCs draw attention by trying to get in or by making excessive noise prior to 4 p.m., the siblings come out to see what's going on. Go to 4 p.m. on the "Timeline" and run it as indicated. If the PCs come here after 4 p.m., the siblings won't be home.

6. COPPER PHILOSOPHY GALLERY

Read the following if anyone enters this building:

This building is a single room. The walls, ceiling, and floor are covered with sheets of copper which radiate soft light. The sheets are covered with neat rows of complex symbols etched deeply in the metal.

The room itself is a single art work representing copper dragon philosophies from ancient times. Though modern copper dragons no longer strictly adhere to these precepts, they are encouraged to study and respect the ideals of their ancestors.

The etchings at first appear to be meaningless scrawls, but if anyone examines a section for at least 10 minutes and succeeds in an Intelligence Check, some of the symbols are recognizable as dragons and men. Many of the images of men appear to have been recently defaced. If the PCs ask any of the good dragons of Cirulon about this, the dragons confirm that an overzealous dragon recently defaced these symbols as a protest against the exploitation of good dragons by the people of Krynn.

Theme. This room represents copper pragmatism, the fundamental precept of ancient copper philosophy. This is the belief that philosophy must change as times change. Various portions of the work symbolize the copper dragons' adoption of gold, silver, bronze, and brass philosophies throughout the ages. In order to determine the correctness of a philosophy, says copper pragmatism, one must first consider the practical consequences of adopting it.

7. WATERFALL

Water empties into a pool from a huge waterfall. There is no apparent source for the waterfall; the water spills from an opening in the sky.

Dragons use the waterfall and pool for bathing and drinking. The source of the waterfall is a conduit from another plane of existence. Excess water seeps through the surface and falls as rain.

If anyone explores behind the waterfall, he discovers a shallow cove carved within a high bank of clouds. A white dragon (**Izark**) cowers in the back of the cove. "Leave me alone," he hisses. "Go away!"

Because white dragons are uncomfortable outside of cold regions, Artha recruited very few of them for her attack on Cirulon. Many were killed, and most of the rest gave up and left. Izark, cowardly by nature, is hiding here, the coolest area in Cirulon. When night falls, he plans to sneak away and fly home.

If the PCs don't attack, Izark huddles against the wall and waits for them to leave. If the PCs don't leave right away, Izark whimpers for them to leave him alone. He refuses to engage in conversation. He fights only in self-defense, using his icy breath weapon, then his bite and claws. He flies away and vanishes into the clouds the instant the PCs leave an opening.

If the PCs aren't overtly hostile but still linger in the cove, Izark attempt to negotiate with them. "Tell me the way out of this accursed city," he hisses, "and I'll tell you how long you have to get out yourselves." Izark wants to know how to leave the city on the ground; he's afraid he might be seen if he flies. The two ground exits are through the entrance columns (1) and through the Dark Area. Of course, Izark will have no way of knowing if the PCs lie to him.

If the PCs tell him the way out, Izark tells them when Artha is planning to destroy the city. (This is planned for about 2 a.m., tonight. Izark tells them how long they've got within an hour either way. For instance, if it is currently 5 p.m., Izark tells them the final attack will occur "in about eight to ten hours.") Ozark says that Artha plans to use a flying tower that will explode in flames if the dragons of Cirulon don't tell her the location of the portal she's looking for. Izark doesn't know any more details about the tower, the portal, or anything else of interest to the PCs.

Even if the PCs don't tell Izark the way out of the city, Izark still tells what he knows if they threaten to kill him. If they return to this area again, Izark is gone.

8. LIVING QUARTERS

These are living quarters used by the dragons of Cirulon. They are described at Location 5.

9. TREASURE DOME

Read the following if anyone enters this building:

This silo-shaped building is half-filled with a dazzling assortment of diamonds, rubies and other precious gems. A ripple of motion indicates that something is moving beneath the surface of the gem pool.

Since visitors to Cirulon are discouraged from bringing treasure, this building provides a pool of jewels for the

dragons to enjoy. They can lounge in the pool, count the gems, or merely bask in their glittering presence to satiate their love of treasure. They are honor-bound not to steal from the pool.

A **giant constrictor** is causing the motion in the pool. Artha placed the serpent here for the next unsuspecting dragon who entered. Having received no visitors (and thus no food), the snake is getting angry and hungry.

If the PCs watch the pool for 2d6 minutes, the snake surfaces. It is unable to reach the doorway and leave the building. If anyone enters the pool, the snake attacks, attempting to grab him within its coils, deliver a bite, then constrict. The snake fights to the death.

The approximate composition of the gem pool: 40% pearls (100 stl each), 20% opals (500 stl each), 20% diamonds (1,000 stl each), 10% sapphires, 9% rubies (2,000 stl each), 1% oversized rubies (5,000 stl each).

10. BRONZE PHILOSOPHY GALLERY

Read the following if anyone enters this building:

Huge paintings cover the walls here. They feature intricate designs of rich reds, deep blues, and other brilliant colors on canvases of solid bronze.

The art works in this gallery represent bronze dragon philosophies from ancient times. Though modern bronze dragons no longer strictly adhere to these precepts, they are encouraged to study and respect the ideals of their ancestors. The less significant paintings restate the concepts of the major works.

Major Works:

Blue on Bronze. This painting, a swirl of deep blues and violets, covers the entire northwest wall.

If anyone studies the painting for 2d10 minutes, he hears a voice in his head asking him for a question. If he succeeds in a Wisdom Check, the magical painting will correctly answer any yes or no question. The painting answers one question per being per day.

Theme. This is a representation of intuitionism, the fundamental precept of the ancient bronze philosophy. Intuitionism is the belief that all knowledge comes from within. Concepts such as good and evil can be understood intuitively through meditation. Logical reasoning and independent testing are not necessary.

Red on Bronze. This painting, featuring dense patterns of bright red spirals, covers the entire southeast wall.

The painting has the same effect as a *sleep* spell on anyone who studies it for more than one minute (save vs. spells to avoid the effect).

Theme. This represents a precept of intuitionism that says a student of philosophy, by strict discipline, can get in touch with the spirit inside and intuitively understand all that can be known. The painting was originally created as a meditation aid by the bronze dragon philosopher Gazzedekiah thousands of years ago.

Ocean of Colors. If anyone approaches the doorway leading to the northeast room, he hears droning, metallic music coming from inside. He also hears a soft, deep voice singing the following:

“Stairways of crystal
Stretch into the sky,
Their roots and leaves grow distant
From where the dragons lie.

Their leaves are golden chairs
For neutral mother's paws,
Where men and women never go
The heart of glorious cause.
Secret places in the clouds
With shadows never far,
Our neutral mother, still she sleeps
Among the twinkling stars.”

The room is not an art work as such, but serves as a draconic meditation chamber. Bands of colors constantly move over all surfaces of the room and soothing flute music plays as an aid to meditation.

Two days ago, an ancient bronze dragon named **Moonscale** entered the chamber to pray and refresh himself before resuming the battle. Unfortunately, as Moonscale began his prayer, the building was hit by a strafing attack from a horde of evil dragons. The attacks disrupted the magic of the room, giving it the effect of a permanent *hypnotic pattern* from which Moonscale has been unable to free himself. He has been frozen here for two days, endlessly repeating his song.

Anyone entering the chamber must save vs. spells or stand motionless, staring helplessly at the swirling colors. He remains enchanted until he is physically removed from the room, or *dispel magic* or a similar spell is cast on him. Since the magical effect is a combination of both sound and color, anyone who covers either his ears or his eyes is unaffected.

Similarly, Moonscale can be freed from the chamber's effect if either his ears or eyes are covered, or if *dispel magic* or similar magic is cast on him.

If freed, Moonscale immediately realizes what has happened and thanks his rescuers. He is friendly and soft-spoken. He introduces himself and tells the PCs what happened to him. If they ask the right questions, Moonscale will answer; he has the same information as Steel-Eye (see 11 a.m.). He will also tell them the purpose of this gallery, and will explain the themes of the major works if they're interested.

Moonscale has a close relationship on Krynn with the Lor-Tai, a primitive tribe living in the wilderness of northern Estwilde. He asks the PCs if they know of the Lor-Tai, explaining that his song is an ancient Lor-Tai prayer (he will not elaborate on its meaning, however). If the PCs participated in the first adventure, they are likely to have stories about M'bert and other Lor-Tai tribesmen. Moonscale hangs on every word; he obviously misses his Krynn friends very much.

Moonscale says he must resume his defense of the city. He will not accompany the PCs, nor will he allow them to accompany him. Before leaving, he gives them a *stone of good luck* which he intended to take home to the Lor-Tai, but which he presents to the PCs as a token of thanks, instead.

11. GOLD PHILOSOPHY GALLERY

Read the following if anyone enters this gallery through the west doorway:

A huge mobile hangs from the ceiling of this room by a thick golden cord. The mobile consists of hundreds of intricately arranged diamonds and silver. It is surrounded by dozens of similar, smaller mobiles.

The art works in this gallery represent gold dragon philosophies of ancient times. Though modern gold dragons no longer strictly adhere to these precepts, they are encouraged to study and respect the ideals of their ancestors.

Each room in this gallery contains a single major work and a number of less significant works. The less significant words restate the themes of the major works.



A **hieracosphinx**, a loathsome creature resembling a cross between a lion and a hawk, is in the center-right room. He has a fondness for precious stones and human flesh, and is trying vainly to pluck the diamonds out of the mobile. If anyone enters this room, the sphinx attacks, slashing viciously in an attempt to drive the PCs out of the gallery. If they flee, the sphinx will not pursue; otherwise, he fights to the death. If the sphinx loses half his hit points, he flees to the rightmost room, flying into the mobile to activate its *displacement* effect before turning to attack once more.

Major Works:

Diamond and Silver Mobile. This room is described in the boxed text above.

Anyone who stands within 10 feet of the mobile feels a tingle ripple through his body. If he remains for two minutes, he must make a Constitution Check. If he fails, he loses 1d4 hp of damage. If he remains for an additional two minutes, he makes a second Constitution Check, losing another 1d4 hp if he fails. If he remains for the full four minutes, he makes an Intelligence Check. If he succeeds, his Intelligence and Wisdom Check penalty for comprehending draconic art is -6 (rather than -12) for the next 1d6 hours.

Theme. This represents gold dragon rationalism, the fundamental precept of ancient gold philosophies. Rationalism is the belief that all knowledge comes from the intellect. The gods do not furnish knowledge directly; knowledge is acquired from observation, experience, and reason.

Onyx and Steel Mobile. The main components of the huge mobile in the center-left room are onyx clusters and steel webs.

Anyone who studies this mobile for 1d6 minutes must save vs. spells or suffer *fear* for the next 2d6 minutes.

Theme. Fulfillment comes from mastering passions and emotions. The wise dragon should order his life through reason, not emotion. These are the teachings of Ana, a gold dragon philosopher from ancient times who took the principles of gold dragon rationalism (see above) to an extreme (Ana's "signature" is the distinctive cluster of three onyx spheres at the top of the mobile). Gold dragon warriors sometimes claim to be guided by the spirit of Ana.

Blue Pearls and Crystal. The main components of the huge mobile in the center-right room are strings of blue pearls and clear crystal cubes. This mobile has no magical effect.

Theme. All systems of knowledge must be consistent; an idea cannot be true if it involves a contradiction. A valid idea must be based on logical principles. This concept was developed by Bylphian, the most revered of all gold dragon mathematicians (see Location 3).

Ruby, Turquoise, and Emerald Mobile. The main components of the huge mobile in the rightmost room are clustered patterns of rubies, turquoise, and emeralds.

The slightest touch causes the mobile to sway for 2d6 rounds, causing a *displacement* of light waves. All those in the room see everyone else appearing to be 1-2 feet from their actual position. All attacks are made at -2 while the mobile sways. This *displacement* effect cannot be countered by a saving throw.

Theme. No theory should be accepted unless its truth can be determined clearly and distinctly. One should be skeptical of anything he cannot confirm with his own experience.

12. NURSERY

Gently sloping platforms lead from the ground to the flat roofs of this small building. A trough is on the roof of the west end of the building. Near the trough lies the body of a copper dragon.

This building is a nursery for the hatchlings of visiting dragons. It is currently occupied by three **hatchling copper dragons**.

Hatchling dragons still learning to fly climb the platforms to practice sailing from the roof. Water in the open trough passes through a valve in the bottom to another trough inside the nursery. Dragons passing by can stop on the roof for a drink from the open trough.

The copper dragon was seriously wounded in a battle last night. Stopping here for water, she noticed that the valve at the bottom of the trough was clogged with chunks of cloud material. While the wounded dragon examined the trough, she was attacked and killed by a flock of homunculi. When dawn broke, the homunculi took refuge in the Silver Philosophy Gallery (17).

If anyone makes it to the roof, he can examine the dragon body. The corpse has a number of deep wounds from last night's battle and has been partially eaten by the homunculi.

From the roof, the party can hear the cries of the frightened, thirsty dragon hatchlings below. The east roof is a sun roof; the PCs can see the hatchlings through this section, pathetically groping at their empty trough.

If the PCs peer into the roof trough, they see three large cloud chunks clogging the opening at the bottom. The water is about 10 feet deep in the trough. Moving each chunk out of the way requires a separate Strength Check from whoever is attempting to unclog the opening.

Once unclogged, water spills into the nursery trough, and the hatchlings greedily lap it up. If anyone manages to get inside the nursery, he finds them to be frightened but healthy. They can't talk. Aside from some soft cloud puffs for nests, there is nothing else of interest in the nursery.

13. MAP ROOM

Read the following if anyone enters this building:

An entire continent in miniature, complete with tiny forests, mountains, trees, oceans, and cities, fills the floor of this single-room building. A gray stone frame surrounds the miniature continent. A map of the celestial realm, including the moons of the night sky, covers the domed ceiling. Another gray stone frame surrounds this upper map.

These maps of the celestial realm and the continent of Ansalon are used to keep track of good dragons. Buildings containing similar maps of the other continents of Krynn have been destroyed in the assaults.

Anyone who succeeds in an Intelligence Check recognizes this as a map of Ansalon. If a good character touches the frame, it changes color. Touching it again causes it to change to another color—the sequence of colors is gold, silver, bronze, copper, and brass. After this sequence is complete, the frame turns gray again.

When the frame turns a particular color, pinpoint of light of the same color blink to life on the map; each point of light indicates the location of a dragon of that color on Ansalon.

Out of respect for their privacy, the light points give only an approximate indication of where each dragon is located; dragons who wish to keep their locations totally secret are not represented at all.

According to the map, there is no particular concentration of dragons, with one exception—a large island north of the continent has a cluster of every color but silver. Anyone who succeeds in an Intelligence Check recognizes this as the Isle of Dragons. (No dragon in Cirulon will tell the PCs why so many dragons have gathered at the Isle of Dragons. See Chapter 4.)

If the PCs can find a way to reach the high ceiling (most likely by *flying* or a similar spell), the ceiling frame activates the same way. If they run through the sequence of colors, they find a significant number of dragons of all colors (except silver) on Lunitari. (No dragon in Cirulon will tell the PCs why so many dragons have gathered on Lunitari. See the Epilogue for details.)

14. HISTORY GALLERY

Read the following if anyone enters this building:

This gallery is filled with ornate statues made of precious stones and jewels.

Some of the works in this gallery commemorate historical events. Others are study aids. The less significant works commemorate historical events chiefly of interest to dragon scholars. Since all dragons have a deep regard for history, this gallery is among the most frequented in Cirulon.

Major Works:

Black Wall. The southern wall is made of pure obsidian. There is a solid black circle about 50 feet in diameter in front of the wall.

Dragons believe that specific aromas can trigger vivid memories. By touching areas of the black wall in certain sequences, aromas are produced which enable a dragon, or any other intelligent creature, to experience racial memories of incidents occurring thousands of years before his birth.

If anyone touches the wall and stands in the circle, he feels a tingling sensation in his body and then smells a strong aroma that seems to flow from the wall and envelop his head. The intense effect lasts only a few seconds. Roll 1d6 and consult the following table for the aroma and the effect.

Roll	Result
1	Sea Water
2	Decay
3	Violets
4	Baking Bread
5-6	No Effect

Sea Water. This is the aroma of salty air blowing on an ocean breeze, triggering vague memories of living in the sea—playfully chasing fish, exploring the murky depths, breaking through the surface to catch the sun's rays. (The implication is that the one touching has evolved from some sort of marine life.) This experience is so soothing that the PC recovers 1d2 hp of damage.

Decay. This is the aroma of rotting meat, triggering vague memories of living in a dark swamp—scraping in the mud for scraps to eat, hiding in cool caves from predators, shaking from fever chills. (The implication is that the one touching has evolved from some sort of primitive swamp-dweller). This experience is so disturbing that the toucher must succeed in a Constitution Check or lose 1 hp of damage.

Violets. This is the aroma of sweet violets, triggering vague memories of floating in a void—formless wisps of color, distant echoed voices, flashes of soft light. (The implication is that the the spirit of the one touching had an existence which pre-dated his physical body.) This experience is so profound that the toucher is distracted for the next hour, making all attack rolls at (MS)1.

Baking Bread. This is the delicious aroma of freshly baked bread, triggering vague memories of infancy—snuggling against a warm body, hearing gentle melodies from a soft voice, watching a colorful butterfly float by in the breeze.

This experience is so relaxing that the one touching immediately falls asleep (no saving throw allowed). He stays asleep until something or someone wakes him up.

Crystal Disk. In the northeast corner hangs a clear crystal disk about 5 feet thick and 25 feet in diameter. It is a *disk of history*, similar to a *crystal ball*, used by the dragons to observe past events. Events are observed in the *disk of history* as a series of silent images, the end of one blending into the beginning of the next.

A user must concentrate on the event he wishes to observe. The event appears in the *disk* in 3d20 minutes. It is important that the user concentrate on a specific event. For instance, concentrating only on a mental image of Artha won't work. However, concentrating on Artha's last stand on the Peak of Clouds in the Astivar Range will display that battle.

Success with the *disk of history* is not automatic. It will not conjure images more than 500 years old. A character can attempt to use it only once per day. A person's base chance of success is 10%. A dragon's base chance of success is 20%. This base chance is modified by:

Any of the following:

For dragons, each age level above very young:	+5%
For others, each point of Wisdom above 15:	+5%
The event occurred on another plane of existence:	-20%
The user has observed the same event in the <i>disk of history</i> before:	+20%

Apply only one of the following:

The event is one in which the user participated:	+20%
The user is well-informed about the event:	+10%
The user is slightly informed about the event:	+5%

The DM may use the *disk of history* to answer questions about previous DRAGONLANCE® game events, as well as to review previous events of this adventure.

Multi-Colored Globes. Near the western wall is an arrangement of multi-colored crystal globes connected by gold, silver, and steel rods. As the viewer changes position, the globes change color. The globes are engraved with intricate symbols. The sculpture has no magical effect.

Theme. This sculpture commemorates the All-Saints War of the gods and the similar war of the dragons which ended with the unification of the neutral and good dragons to defeat the evil dragons. The sculpture also represents the existence of the Astral Dragon, a neutral dragon who is the ancestor of all dragons and who lives on another plane of existence.

15. BRASS PHILOSOPHY GALLERY

Read the following if anyone enters this building:

This room appears to be the site of a recent battle. The walls are scorched and cracked. Shards of crystal and twisted scraps of metal cover the floor. A mass of bloody red and brass dragon bodies lies in the center.

This room originally contained the mosaic sculptures embodying ancient principles of brass dragon philosophy, but every work has been destroyed. Three brass dragons were pursued here by two red dragons. The ensuing battle demolished the gallery, as the dragons killed each other.

Theme. The bronze philosophies (no longer discernable) represented in this room had to do with the innate superiority of some dragons over others and the importance of allowing these naturally superior dragons to flourish, even at the expense of the inferior.



16. SUNNING COLUMN

This and the other two platforms are used by the dragons for observation and to bask in the sun. Most have been destroyed in the assaults on the city; only three remain.

17. SILVER PHILOSOPHY GALLERY

This building has a deep crack in the ceiling resulting from the strafing attacks. Read the following if anyone enters:

Pulsating globes of light drift silently through this dark building. The light globes twinkle and shimmer in a rainbow of colors.

The art works in this gallery are immense sculptures of pure light. All illumination is provided by the soft glow of the light sculptures.

The art works represent silver dragon philosophies of ancient times. Though modern silver dragons no longer strictly adhere to these precepts, they are encouraged to study and respect the ideals of their ancestors. The less significant sculptures restate the ideas of the major works.

Four **homunculi**, man-made monsters resembling a cross between a man, a bat, and a lizard, about 18" tall, killed a copper dragon at the nursery last night (see Location 12), then came here through the crack in the ceiling. They are lurking behind the Fading Rainbows sculpture (see below). If anyone approaches the Fading Rainbows sculpture, they fly out, flapping their wings and snapping at random PCs in an attempt to put them to sleep. The homunculi fight to the death.

As soon as one of the homunculi is killed, a surviving homunculus panics and flies through the Fading Rainbows sculpture, triggering the *blindness* effect (see below). The homunculus who triggered the effect is *blinded*; his surviving comrades aren't affected. The *blinded* homunculus flies helplessly around the room for the next five rounds. The homunculi avoid looking at the sculpture for the remainder of the fight and won't intentionally trigger it a second time.

Major Works:

Sparkling Dust. This work, near the southwest doorway, appears as clouds of twinkling silver dust that repeatedly form sharply-angled multi-colored patterns, then break up again into silver clouds.

Two or more PCs who study the sculpture together for 2d10 minutes feel a tingling in their heads. If they succeed in Wisdom Checks (no more than one attempt per day), they will be able to communicate by *telepathy* for the next 2d6 hours. The *telepathy* is effective for up to 50 feet.

Theme. This is a representation of silver dragon spiritualism, the fundamental precept of an ancient silver philosophy. Spiritualism is the belief that all knowledge comes directly from the gods, who also direct the flow of history. Only the gods give knowledge; truth can come from no other source.

Blinking Spheres. In the northeast wing is a mass of blinking yellow, orange, and lime-green spheres that periodically flash streams of dazzling white light in all directions. Indistinct images like faint wisps of smoke appear and disappear inside the spheres.

Anyone who studies these spheres for more than 2d20 minutes must save vs. spells or all that he looks at will appear as waving, shifting outlines, causing all attack rolls to be made at -2 for the next hour.

Theme. Good and evil cannot be known directly by dragons. Like all knowledge, the principles of goodness are

gifts from the gods of good. The purpose of a silver dragon's life is to devote himself to the standards of good established by the gods.

Fading Rainbows. Extending from floor to ceiling of the southeast wing, this is a gigantic tangle of twisted, pulsating rainbows. Images of silver dragon heads silently mouthing words can be faintly seen inside the rainbows.

Strafing attacks on the gallery have disrupted this delicate sculpture. Anything which passes through the sculpture causes a flare of brilliant light that inflicts *blindness* on anyone looking in its direction. The *blindness* lasts for 2d6 minutes. Those who successfully save vs. spells are unaffected.

Theme. Silver dragons who live up the gods' standards of goodness are rewarded in the afterlife. With the blessing of the gods, the spirits of the dead can communicate with the living through dreams. Unfortunately, since this work has been disrupted, it is not possible for anyone to understand it without an explanation.

18. LIVING QUARTERS

These are living quarters used by the dragons of Cirulon. They are described at location 5. Location 18 is home to Kerrija and Terrilyn, the silver dragon siblings (see 4 p.m.). The siblings are inside prior to the daily appearance of the rainbow. If the PCs make themselves noticed by trying to get in or by making excessive noise prior to 4 p.m., the siblings come out to see what's going on. Go to that point on the timeline and run it as indicated. If the PCs come here after 4 p.m., the siblings won't be home.

19. ARMAMENT REPOSITORY

The west side of this building has been demolished by the strafing assaults. The PCs can enter through the doorway or through the demolished west wall. If anyone enters, read the following:

Much of this building is in ruins. Rubble litters the floor. A few assorted weapons hang from the walls.

On the south side of the room, a black dragon claws and butts against a red doorway with little success. A large man dressed in black armor and armed with a long sword is yelling at the dragon. "Open it! I command you!"

This building is a repository for weapons collected by the dragons for study. Because the collapsed wall gave easy access to looters, only a few weapons remain.

The red door, which can only be opened by a character of good alignment, leads to a room containing a single *mounted dragonlance* complete with a harness mount. Since the *dragonlance* is the weapon most feared by dragons, it is kept in a secure place of its own.

The man is **Finion Pel**, a commander of the Black Dragon-army from the east coast of Goodlund and one of the few humans Artha trusted enough to recruit for the assault on Cirulon. The dragon is his mount, **Nightclaw**. Pel suspects the door leads to a great treasure, but their efforts to break in have been in vain.

Nightclaw senses the PCs as soon as they enter the repository and roars at them. "You!" snarls Pel at the nearest PC. "Open this door or you'll die where you stand!" If the PCs resist, he repeats his demand. If the PCs still don't comply, Pel and Nightclaw attack, as Pel assumes the PCs are there to claim the treasure.

Pel refuses to negotiate. He and Nightclaw are vicious killers, eager and willing to fight to the death. They waded into

the PCs, Pel attacking with his sword, Nightclaw leaping in the air to attack with his claws and bite. (The room is too small to allow full swoops and fortunately for the PCs, Nightclaw has exhausted his breath weapon on the door.) If the party flees, Pel mounts Nightclaw and pursues. If either Pel or Nightclaw is killed, the survivor, consumed with vengeance, brutally continues the fight, pursuing if necessary.

If the PCs agree to open the door, Pel peers in to see the *dragonlance*, claims it as his own, then attacks the PCs as outlined above, fearful they will steal this treasure. He doesn't realize until too late that the door has once more closed upon the smaller room.

If the PCs survive the fight with Pel and Nightclaw, they can examine the room. A sample of each of the following weapons still hangs from the walls: trident, spear, halberd, hammer, short sword, scimitar, and quarter staff.

If the PCs search the rubble, they will also find a two-handed sword, a throwing axe, a *short sword +1*, a *mace +4*, an *axe +2*, and a quiver of 12 *arrows +2* (20% chance per PC per 10 minutes of searching to find each item).

The *mounted dragonlance* is 16 feet long and gives off a silvery metallic glow. The head is sharpened to a fine edge with small barbs protruding from the sides. This particular lance does 2d4 + 1 hp of damage to man-sized foes and 3d6 hp of damage against larger targets. Against a dragon, it inflicts damage equal to the hp of the wielder plus those of his mount. If not mounted on a dragon, it causes normal lance damage. It has an additional +2 bonus to hit when mounted on a dragon. The *mounted dragonlance* is ineffective on mounts smaller than dragons because of its weight. The adjustable harness allows the *dragonlance* to be mounted on a dragon of young age or older. (At this time, no dragon in Cirulon will agree to become a mount for the *dragonlance*; the situation may change in Chapter 2.)

20. SUNNING COLUMN

This and the other two platforms are used by the dragons for observation and to bask in the sun. Most have been destroyed in the assaults on the city; only three remain.

21. COUNCIL CHAMBER

This building contains the council chamber for the Council of Cirulon and the living quarters for the council members.

The council chamber is a single room with a domed ceiling. The room contains six nests of comfortable cloud material. The members sit in these nests during council meetings. Five of the nests are identical in size and are elevated about 50 feet above the floor. A metal frame enclosing the nest identifies its owner—gold, silver, bronze, copper, or brass. The sixth nest rises 60 feet from the floor and is enclosed by a clear crystal frame. This nest is used by representatives from the plane of the Astral Dragon and other dignitaries. A map of the celestial realm, similar to that in the Map Room (13), covers the ceiling.

The living quarters are identical to each other. Each consists of a single room lined with pieces of Density 1 puffs, for nests. All have red doors so only the occupant has access. Each room also contains a 20-foot diameter *disk of history* (see the History Gallery (14)) for personal use. The living quarters, moving clockwise from the main chamber entrance, are assigned as follows: a. Alcuin; b. Strato; c. Anaximander; d. Spir; e. Tertullian.

On this day, the dragon council members are all in their living quarters. They will remain there until 2 a.m. (see Chapter 2). They will not respond to any communication from the PCs. If the party should somehow manage to enter one of the

living quarters, the occupant insists they leave immediately, summoning the other council members to enforce this if necessary.

TIMELINE

8:45 a.m., Eyewings. Three hideous creatures soar through the clouds about 100 feet overhead. Their bodies are oval balls of matted black fur about 5 feet wide dominated by a single, bulging 4-foot-wide eyeball. The eyeball is black with a blood-red pupil that continually leaks bluish fluid. Leathery bat wings, each 5 feet long, extend from their bodies. Each wing ends in three razor-sharp talons. An 8-foot rat's tail hangs limply below.

These are **eyewings**, evil servitors of Artha, scouting the city for victims.

The eyewings disappear into the clouds, make a sweeping circle, and return to the same area two rounds later. If the PCs aren't in plain sight (for instance, if they hid behind a puff or inside a travel tunnel), the eyewings leave.

If the eyewings can still see the PCs, they attack. One eyewing hovers overhead, attempting to drip tears on random PCs. The others swoop low, attacking random PCs with their claws and tails. The eyewings fight to the death, pursuing if necessary. If the PCs escape through a doorway, the eyewings try to follow before the doorway closes.

9:45 a.m., Battling Dragons. A deafening roar draws the party's attention to the heavens. Two white dragons are gripped in combat with a much larger and older copper dragon. They tumble through the clouds, clawing, biting, and blasting each other with acid and ice.

The battle is too far away for anyone to interfere. The battle rages for less than a minute, then the dragons disappear into a thick cloud bank.

Just after 10, skies darken and the winds wail.

10:15 a.m., First Strafing. The dragons swoop though the city as described above, randomly blasting their breath weapons (acid, lightning, fire). The breath weapons have no effect on the buildings.

The strafing lasts three rounds. Each round that any one is within 150 feet of the Strafing Pattern line while the dragons are strafing, roll 1d8 and consult the following table. Even if someone is hit, he may negate the effects with a successful save vs. breath weapon.

Anyone who stays inside a travel tunnel or building is safe from all strafing attacks.

Roll	Result
1-5	No attack hits.
6	Fire breath weapon hits (6d6 hp of damage).
7	Lightning breath weapon hits (6d6 hp of damage).
8	Acid breath weapon hits (2d4 hp of damage).

11 a.m., Steel-Eye. A huge gold dragon swoops from the sky and lands in front the party. One of his eyes is missing, replaced by a steel sphere. His back right leg is also gone, replaced by a steel leg.

The dragon cocks his head and looks the party over. "Well, well," he says. "What have we here?"

Steel-Eye has served as a guardian of Cirulon for centuries. A shrewd and fearless fighter with a nasty sense of humor, he is a veteran of countless military operations, losing an eye and a leg in the process.

Steel-Eye spotted the PCs while patrolling the skies above the city. Aware of rumors that good people from Krynn were being brought in to help with the city's defense, he has already used *detect good* on the party and presumes they're



here to help. However, as he would with any potential ally, he wants to size them up for himself.

If the PCs are hostile, elusive, or otherwise uncooperative at any point, Steel-Eye snorts, "There's too much at stake to waste time with games." If the party remains uncooperative, Steel-Eye flies away and resumes his patrol. However, if the PCs cooperate and speak openly, Steel-Eye is friendly, though a bit intimidating.

Steel-Eye asks their names, then introduces himself. "Now, tell me your purpose here." If they tell him why they're in Cirulon, Steel-Eye nods and says, "Good. We'll take all the help we can get. Perhaps you have questions?"

If the PCs have no questions, he wishes them luck and flies away. If they have questions, he says, "Before I can trust you with an answer, I need a favor first. Who among you will volunteer?" Steel-Eye insists they choose a volunteer before he tells them what he wants them to do.

When a volunteer is chosen, Steel-Eye asks him to come forward. Steel-Eye then crouches low until his head is within inches of the PC's face. "I have," whispers Steel-Eye, "a bad tooth. Pull it out." Steel-Eye opens his jaws wide. About two feet back on his bottom row of teeth is a discolored fang. Though Steel-Eye is resourceful enough to dislodge the tooth himself, he is testing the character's courage.

If he refuses to pull out the tooth and no one is willing to take his place, Steel-Eye snorts in disgust and flies away.

If the character agrees to pull out the tooth, he must reach inside Steel-Eye's mouth. He feels Steel-Eye's hot, moist breath on his face, heavy with the aroma of raw meat, and gets a good look at the rows of razor-sharp fangs lining his mouth. To add a touch of drama, Steel-Eye growls menacingly when the arm is in his mouth.

Steel-Eye won't allow any use of rope or a tool to pull the tooth. ("You will not put that filthy object in my mouth," he snarls.) To pull the tooth, the PC must make a successful Strength Roll (-1 penalty). If he fails, someone else can try.

If the tooth is successfully pulled, Steel-Eye says, "Much better. Thank you." If they are unable to pull the tooth, but have given it a good try, Steel-Eye dislodges the tooth with his tongue and spits it out, thanking them for their help.

Once the tooth is out, Steel-Eye will answer the party's questions. If they ask about the city, he explains that it was a gift from the gods and that the dragons have used it for centuries as a refuge and as a stronghold for some of their most valuable treasures; he will not explain what the treasures are.

If asked about the attacks on the city, Steel-Eye explains Cirulon's defensive aura was weakened several months ago when the moons began to fade. Since then, the city has been under assault from evil dragons and other minions led by a monstrous goddess named Artha, a toadish woman rumored to be the daughter of Takhisis herself.

If asked about the portal the evil minions seem to be seeking, Steel-Eye is elusive, unwilling to trust them with this secret. "Let us say that what they are seeking is not to be found in Cirulon."

Steel-Eye has no knowledge of the black tower the PCs saw in their dreams. He will, however, warn them of regular assaults by a force of evil dragons (the strafing attacks). He warns them to take cover when the sky grows dark and they hear the sounds of howling wind.

Steel-Eye knows the location of the *dragonlance* (the Armament Repository (19)) and can also tell them the location of any other building they are looking for. If they ask him about the *dragon wings*, he eyes them with amusement, and will say only, "Sorry. I'm afraid I'm not the right type."

When the questions are over, Steel-Eye says he must resume his patrol. He wishes them luck. "Perhaps we shall meet again," he says, then soars away into the clouds.

The party can keep Steel-Eye's fang. It has a value of 10,000 stl and can be used as a *dagger +2*.

12:30 p.m., Dragon Gang. Sounds of snorting and roaring can be heard about 150 feet ahead. If the party investigates, they discover three **young blue dragons** sniffing along the surface, occasionally snorting and roaring at each other.

These are blustery male dragons looking for trouble, the draconic equivalent of a street gang. If the PCs don't attract attention to themselves, the dragons won't notice them and will soon move away. (Make sure the PCs understand the danger in provoking a group of evil dragons.)

If the dragons spot the party, they attack, but only for one round, after which they hover in the air over the PCs' heads. "Where's the portal?" demands one of the dragons. "Tell us, or we'll kill every last one of you."

The PCs may or may not know that the dragons are looking for the portal to the Astral Dragon's plane, but it's in their best interests to pretend they do. Whatever the PCs tell them, the dragons immediately fly away, each anxious to be the first to find it (they don't trust each other enough for one to stay behind to finish off the PCs).

If the PCs don't give them a portal location, the dragons attack for another round, then repeat their request. This continues until they get an answer, one of the dragons is killed (at which point the rest flee), or all of the PCs die.

Just after 2, skies darken and the winds wail.

2:15 p.m., Second Strafing. This is identical to the First Strafing (see 10:15 a.m.).

2:45—3:45 p.m., Thunderstorm. As a result of disruption from the strafing, a thunderstorm blows up a half-hour after the strafing ends—strong winds and heavy rains. The storm lasts for an hour, then dissipates, and Cirulon's normally pleasant weather resumes.

The following penalties are in effect during the storm. The penalties are not applicable inside buildings and travel tunnels. All effects are cumulative with any other adjustments.

1. All outside combat is at a -4 penalty.

2. The following additional attack penalties are in effect for missile combat: -2 at short range. Medium and long range attacks are impossible.

3. Determine wind direction randomly by rolling 1d6: 1 = NE, 2 = E, 3 = SE, 4 = SW, 5 = W, 6 = NW. Movement is at half normal rates when moving into the wind, and at two-thirds normal rates when moving perpendicular to the wind direction.

4—5 p.m., Rainbow. This is a natural phenomenon that occurs at the same time every day. The rainbow, a band of shimmering colors about 100 feet wide, extends over the city from the entrance columns (Location 1) to beyond the Council Chamber (Location 21). The rainbow lasts for one full hour, then vanishes.

While it lasts, the rainbow radiates *protection from evil* over the entire city, though the effects do not extend into the interiors of buildings or travel tunnels. Since the evil minions know the effects are only temporary, they hide or withdraw until the rainbow fades away. Minions already engaged in combat when the rainbow appears continue to fight.

This is also the time of day that Terrilyn and Kerrija, the silver dragon siblings, scout the city. The party will meet them at 4 p.m., or soon thereafter (see below).

4 p.m. or later, Siblings. As the party nears the side of a building (or if in a travel tunnel, the next time they walk through a doorway), a silver dragon pounces on the character bringing up the rear of the party (if more than one is bringing up the rear, choose randomly). The dragon knocks him down and pins him with her foot. "Identify yourself, intruder!" she says in a high voice. The dragon is small and doesn't appear to be particularly threatening.

Before the pinned character or anyone else can react, a second silver dragon swoops to the side of the first. "Terrilyn!" he says with disgust. "Let him up!" Terrilyn sheepishly obeys. "Sorry," she mutters. The male continues his scold-



ing, oblivious to the party. "What is the matter with you? Does your word mean nothing? I am ashamed to call you my sister!"

Kerrija and **Terrilyn** are brother and sister, the only living descendants of the silver wyrm Tertullian (see Chapter 2). Though very close in age, their personalities are strikingly different. Kerrija, the younger of the two, is cautious, studious, and inclined to worry excessively. Terrilyn is impulsive, adventurous, and inclined to get into trouble. Since they have no parents, Kerrija does his best to look after his trouble-prone older sister. Terrilyn whole-heartedly resists her brother's well-meaning but somewhat condescending efforts. In spite of their constant squabbling, they are devoted to each other.

Kerrija and Terrilyn are in training to become caretakers and custodians of Cirulon, a tradition extending back through generations of their family. One of them will eventually take Tertullian's place on the Council. Tertullian has forbidden them to participate directly in combat of any kind; as the only surviving family members, she feels their lives are too precious to risk. Terrilyn is none too pleased with her fate. Kerrija dutifully accepts it. Neither has ever been outside of Cirulon.

Each day when the rainbow appears, Kerrija and Terrilyn patrol the city. Though Kerrija is the only sibling with spells, Terrilyn has a remarkable sense of smell. It was Terrilyn who sniffed out the party.

When Kerrija finishes chewing out Terrilyn, he demands that she apologize, which she does. Kerrija introduces himself and his sister, saying they are "caretakers-in-training of the great galleries of Cirulon." He then shyly asks their names, where they're from, and why they're here.

As soon as it dawns on her that they're from Krynn, Terrilyn perks up and excitedly begins to question them: "What's it like there? Is everyone like you? What are the dragons like? Do you have cities like these?" Terrilyn is especially interested in the War of the Lance, asking them if they participated in any battles themselves or knew anyone who did. She hangs on every word, as if they were the most fascinating characters she's every met.

Terrilyn has the same information as Steel-Eye (see 11 a.m.), which she freely shares if they ask the right questions. If they ask about the portal the evil minions are looking for, Terrilyn says, "You're right. They're looking for the portal. But they'll never find it because it isn't here!" Kerrija angrily tells Terrilyn to be quiet. Terrilyn won't comment further about the portal.

If the PCs ask about the *dragon wings*, Terrilyn becomes especially excited. "Can we tell them about the *wings*?" she asks her brother, who responds with a stony stare.

As the conversation continues, Kerrija grows increasingly exasperated with his sister's loose tongue, finally interrupting her with a brusque nudge from his tail. "Time to go now. We have things to do. Besides," he adds, glancing nervously at the PCs, "I'm not so sure it's a good idea to associate with people, under the circumstances."

Terrilyn is outraged at this remark, saying she believes the rumors about the problems between good dragons and good people are nonsense. "Maybe it's you who's forgotten what you've learned," she snaps at him. Terrilyn adds that she also believes the stories about a group of good people coming from Krynn to help Cirulon and "these are the people! We should help them if we want them to help us!"

"Even if we wanted to," Kerrija says, softening, "what could we do?"

Terrilyn says they could help the people with the *dragon wings* (if the PCs haven't mentioned the *dragon wings*, Terrilyn has smelled them and therefore knows the PCs have them). She says the *wings* are a great treasure that silver dragons gave to people in ancient times to share with them

the gift of flight. A female dragon gives the gift to a female person, a male dragon to a male person. Would any of the females care to try?

If there is a female volunteer, Terrilyn takes the *dragon wings* and asks her to come close. Terrilyn holds her tightly to her chest, pressing the *wings* against her back. The character feels a burning sensation that spreads from her neck through her shoulders and down her spine as the *wings* are absorbed into her body.

After a minute passes, Terrilyn releases her. Wracking pain shoots through the character's body; she must make a Constitution Check. If the check fails, she loses 1d6 hp of damage. If the check succeeds, she loses 1 hp of damage.

The pain subsides in 1d4 minutes, after which a pair of glittering silver dragon wings blossom from her shoulders. Remarkably, they neither destroy nor interfere with her clothing or armor, but pass through as though incorporeal. The wings are covered with silver dragon scales and span 12 feet when extended. They are fully functional; with them, she can fly at the same speed as a silver dragon (FI 30). The wings remain for 24 hours.

Terrilyn gladly repeats the process for any other female characters, but only a male silver dragon can activate the *dragon wings* for a male. Kerrija steadfastly refuses, and no amount of coaxing makes him change his mind. (No other silver male dragon in Cirulon is willing to help the male characters with the *dragon wings*, as most still harbor suspicions about good people. However, the male PCs will get another chance with Kerrija in Chapter 2.)

Eventually, Kerrija insists that the two must resume their patrol. Terrilyn reluctantly agrees, but suggests that they decide on a place to meet later "in case of a big emergency. Good dragons and good people are destined to work together." Terrilyn agrees to any meeting place suggested; if they don't have a suggestion, Terrilyn recommends the entrance columns (Location 1). Kerrija won't allow Terrilyn to specify a time, saying, "I suppose if we need to find you, we will."

Terrilyn says good-bye then she and her brother fly away. Kerrija will not allow the party to accompany them, nor will the dragons accompany the PCs.

Just after 6, once more skies darken and winds begin to howl.

6:15 p.m., Third Strafing. This is identical to the First Strafing (see 10:15 a.m.).

6:30 p.m., Sunset. Dusk is quickly swallowed by a second thunderstorm (below).

6:45—7:45 p.m., Thunderstorm. As a result of disruption from the strafing, another thunderstorm blows up a half-hour after the strafing ends, complete with strong winds and heavy rains. The storm lasts for an hour, then dissipates, and nighttime stars peek out from behind the remaining clouds.

During the storm, the sections of travel tunnels marked with fault lines collapse and crumble. The Treasure Dome (Location 9) also collapses, just after 7 p.m.

When the Treasure Dome collapses, jewels spill out into drifts surrounding the dome for a radius of 50 yards (see Location 9 for information about the jewels). If still alive, the starving snake emerges from the debris to search the city for victims, and can be used as a random encounter (see Random Encounter 5, below, for details).

8:30 p.m., Thief. When the party is off-guard, an **imp** quietly emerges from beneath the Density 1 surface and snatches one of their possessions, possibly a weapon (such as Steel-Eye's fang), the ears of corn from Abriele, the *staff of curing*, or one of their *dragon wings*. The imp flies over their heads, taunts them with his theft, then begins to flap away, pausing as necessary to give them a chance to follow.

The imp served as a familiar to an evil mage named Dragh, one of Artha's lieutenants. After Dragh was killed in yesterday's assaults, the imp decided to remain in the city, wreak-



ing havoc, until he received orders from a new master.

The imp will attempt to lead the party to the Dark Area. If the party follows him there, go immediately to the Dark Area description in "Features of the City", above.

If the PCs manage to overtake the imp, he goes *invisible* and flees to safety. If he still has the stolen item, he mocks them again, still attempting to lure them to the Dark Area. If they overpower him, the imp *polymorphs* into a raven and attempts to fly away and vanish into the Dark Area.

10 p.m., Final Assault. When 10 p.m. arrives, Artha begins her final assault against the city. The events of Chapter 1 are over. Go immediately to Chapter 2.

RANDOM ENCOUNTERS

If your party is having too easy a time of it, too hard a time, or needs something else to occupy it, you might include one or more of the following random encounters. The first five (**Weather Pocket, Static Disturbance, Dripping, Bad Ceiling** and **Loose Snake**) are hindrances. The next two (**Wounded Dragon** and **Treasure**) are helps, while the last three (**Corpse, Soaring Dragon** and **Battling Dragons**) are neither. Most encounters in which the enemy fled can be repeated, as well.

1. Weather Pocket. This can only occur if someone is walking on a Density 1 surface. Parts of this material have been disrupted by the barrage of evil assaults. The body weight of the party as they make their way through the clouds triggers a temporary weather disturbance in an area with a radius of 20 feet (measured from the approximate center of the party). The effect lasts 2d6 rounds, then normal weather resumes. Roll 1d6 to determine the effect.

Roll	Result
1-2	Static
3-4	Soggy
5-6	Fog

Static. The area crackles with static electricity. For each round spent in the area, each PC must make a successful Constitution Check (+2 bonus) or suffer 1d2 hp of damage.

Soggy. The area becomes as soggy as quicksand. For each round spent in the area, each PC has a 20% chance of sinking at the rate of 1 foot per round. If the PC succeeds in a Dexterity Check, he finds a solid surface to grab. If he then succeeds in a Strength Check, he pulls himself free.

Any single PC can pull the sinking PC free if he makes a Strength Check at -2. Any two PCs working together can pull him out with no problem. If normal weather resumes, he is stuck tight, but can be pulled free as if he were sinking.

If the PC sinks below the surface, he can still be rescued as long as his companions can feel around and find him. However, the PC continues to sink at a rate of 1 foot per round. If not rescued before he sinks out of reach, he will never be seen again. (The cloud foundation is at least 1000 feet thick.)

Fog. A heavy fog rises within the affected area. Normal vision is reduced to 10 feet.

2. Static Disturbance. While in a tunnel, the area surrounding the PCs begins to crackle with static electricity. Certain sections of the travel tunnels have been disrupted by the barrage of evil assaults. The body weight of the party has triggered a temporary disturbance in an area with a radius of 20 feet (measured from the approximate center of the party) extending up around the walls and across the ceiling. The effect lasts 2d6 rounds.

The electricity has no effect for the first round. After that, for each round spent in the area, each PC must make a successful Constitution Check with a +2 bonus or suffer 1d2 hp of damage.

3. Dripping. While in a tunnel, thick liquid drips from the ceiling like rain for the next 20 yards, forming small pools on the floor.

A flock of eyewings hovering over the top of the tunnel dripped tears on it in an attempt to get inside. The attempt failed, but the tears managed to burn cracks in the ceiling. The tears are now dripping inside the tunnel.

Anyone moving through the rain of tears has a 20% chance of being dripped on. There is no chance of being dripped on if he holds a shield over his head or similarly protects himself as he moves through the area. He can also wait it out; the drips stop in 1d4 hours.

Anyone dripped on must save vs. poison, suffering 2d6 hp of damage if the roll fails and 1d6 hp of damage if the roll succeeds. The pools of tears on the floor are easy to avoid, but anyone foolish enough to intentionally touch a pool must save vs. poison and suffer the appropriate damage.

4. Bad Ceiling. This section of the travel tunnel has been disrupted by the barrage of evil assaults, and chunks are falling out. The chunks range in size from a few inches in diameter to about 3 feet in diameter. The bad ceiling extends for 3d20 yards ahead of the party.

The party can either find another route or attempt to pass beneath the crumbling ceiling. If they pass under the ceiling, each one has a 30% chance per 10 yards of ceiling of being hit by a chunk large enough to do damage. A PC has a chance to dodge a falling chunk by making a successful Dexterity Check. Anyone hit by a chunk suffers 1d4 hp of damage.

5. Loose Snake. When anyone is adjacent to a building or travel tunnel, a **giant constrictor** drops on him from above. The hungry snake attempts to grab him within its coils, deliver a bite, then constrict. The snake fights to the death and will pursue through a doorway if possible.

This is the snake from the Treasure Dome (Location 9). This encounter can only take place after 7 p.m.

6. Wounded Dragon. The party hears moaning just ahead. A bronze dragon is hidden in the shadows of a building (or other structure, depending on the current location of the party; if they are in a travel tunnel, the dragon is hiding around the next corner or is just inside the doorway the next time they enter a new travel tunnel). The dragon, clearly in pain, is rubbing a gaping wound in his head. Half his face has been slashed, and blood trickles from his right eye.

The dragon doesn't notice the party unless they draw attention to themselves or until they come within 20 feet of him. He then lurches to attention and roars. "How many of you now?" he gasps. "I'll kill every one to the last." He blasts a lightning bolt breath weapon in their direction, just missing the tops of their heads.

Papian was severely wounded in a sky battle with two black dragons when a claw attack from one of the dragons sliced his face. Papian took refuge here to tend his wounds.

Papian's vision is blurred, and he is in agony from his wound. He presumes the PCs are minions sent to finish him off.

If they make no threatening moves, Papian will wait before attacking again. If they do threaten him, Papian attacks with *magic missile*, then his gas cloud breath weapon. If they retreat, Papian will not follow.

Papian is skeptical of anything the party says; he doesn't believe they came from Krynn to help nor is willing to take them at their word that they mean him no harm. However, if they convince Papian they've encountered a dragon he's heard of (any of the good dragons of Cirulon will do, most likely Steel-Eye (11 a.m.), Saramber (Prologue), or Kerrija and Terrilyn (4 p.m.)), he listens more attentively. If the PCs then soothe him by assuring him they're on his side, he says he won't hurt them and will allow them to pass. He offers no help nor will he answer any questions.

TROUBLESHOOTING

Here are some tips for handling unexpected problems:

If the PCs don't make friends with Kerrija and Terrilyn: If the PCs are hostile to Kerrija and Terrilyn at their first meeting, have the siblings encounter the PCs again before 2 a.m. Terrilyn stresses the importance of cooperation, possibly offering them a friendship token (such as a silver pendant) to demonstrate their sincerity.

If the PCs don't find the *dragonlance* or learn the secret of the *dragon wings*: Don't worry about it. Though helpful, these items aren't necessary.

However, if they attend to Papian's wound, they find him much more cooperative. If they heal 8 hp of damage (with *potions of healing*, the *staff of curing*, or similar magic), he is healthy again and his vision returns. If they have no magical resources, but still attempt to relieve Papian's suffering (as by offering him water or bandaging his wounds), Papian accepts them as friends.

If they help with his wounds, Papian answers their questions. He has the same information as Steel-Eye (11 a.m.), except that he doesn't know the location of the *dragonlance* and doesn't recognize the *dragon wings*. As a reward for helping him, Papian tells them of an object he spotted protruding from the surface about 150 feet ahead of the direction the PCs are heading. (If they search the area Papian is indicating, go immediately to Random Encounter 7.)

If Papian is healed, he flies away. Otherwise, he rests here until he feels better; if the PCs return, he will be gone.

7. Treasure. The party spots the edge of an item protruding from the surface of clouds on which they are walking. The object was lost by an evil minion.

Roll 1d4 to determine the item. Each item can be found only once; if an item is rolled a second time, either roll again or treat as no encounter.

Roll	Result
1	bone club (dmg 1d6)
2	<i>mace</i> +2
3	<i>wand of magic missiles</i> (12 charges)
4	steel skull pendant (worth 3,000 st!)

8. Corpse. The party discovers the corpse of a dragon, a battle casualty. The dragon, killed within the past day, is already sinking into the clouds where it will eventually dissipate. *Raise dead* or similar spells have no effect.

Roll 2d6 for the type of dragon corpse encountered, once for its color and once for its age.

Roll	Color Result	Age Result
1	gold	juvenile
2	bronze	young adult
3	copper	adult
4	red	mature adult
5	blue	old
6	green	very old

9. Soaring Dragon. A dragon soars through the clouds overhead, vanishing in the distance. The dragon is searching the sky for foes. If evil, the dragon is too far away to attack. If good, the dragon is flying too fast to respond to signals from anyone.

Roll 1d6 on the table above to determine the color of the dragon.

10. Battling Dragons. Roll 1d6 to choose opponents:

Roll	Result
1	gold vs. red (enveloped in sheets of fire)
2	blue vs. bronze (blasting lightning at each other)
3	gold vs. three blacks (the black dragons are swarming over the gold dragon who vainly tries to shake them off)
4	green vs. copper (barely visible in clouds of gas)
5	red vs. silver (red has silver by the neck)
6	blue and red vs. two brass (tangle of bodies clawing and snapping at each other)



CHAPTER 2: NIGHT OF FIRE

DM's OVERVIEW

This chapter begins at 2 a.m., immediately after the events in Chapter 1. Use the large color insert map of Cirulon and map 2 (p. 30). All events of this chapter take place in or above Cirulon.

In this chapter, the PCs should:

- confront the dark tower they saw in Saramber's dream,
- undergo an inquiry at the Council of Cirulon, and
- embark on a mission of mercy to Schallsea.

DM's BACKGROUND

Artha recently contacted a band of Black Robe wizards and dark clerics in Kajhun, a remote area near Sanction, promising them a share in the rule of Krynn if they created powerful weapons for her. The mages and clerics created two flying towers, magical reconnaissance devices with an awesome capacity for destruction. Artha is using one of the towers for a final assault on Cirulon, keeping the other tower in reserve.

THE TOWER APPEARS

The events of this chapter begin at 10 p.m. Regardless of the PCs' location, they hear roars of thunder from high overhead and feel the city begin to shake. If they are inside a building or travel tunnel, increase the intensity of the shaking until they go outside; if necessary, have pieces of the ceiling break off and fall on them.

A gray fog swirls over the city as the thunder intensifies. An image of an obese woman dressed in black rags appears in the fog, and the aroma of rotten meat sweeps through the air. This is Artha; the PCs recognize her if they participated in the first adventure.

Artha's low, sluggish voice booms across the city. "You have one more chance to tell me the location of the portal," she says. "Four hours." The fog swirls around her, and the image disappears.

The sky lightens, and the thunder and shaking stop. Rising from below the eastern edge of Cirulon comes a black tower sitting atop a chunk of stone. The tower floats silently in the air, advancing toward the city. A red dragon perched on the tower surveys the scene below.

The tower is identical to the one in the dreams the PCs experienced before coming to Cirulon (see Prologue).

PATH OF THE TOWER

The tower is moving at one mile per hour (100 feet per minute). It will move from building to building in the following sequence, hovering over each for 20 minutes before moving on to the next.

1. Copper Philosophy Gallery (Location 6)
2. Bronze Philosophy Gallery (Location 10)
3. Silver Philosophy Gallery (Location 17)
4. Gold Philosophy Gallery (Location 11)
5. History Gallery (Location 14)
6. Council Chamber (Location 21)

Once it reaches the Council Chamber, the tower hovers in place until 2 a.m. (see "Explosion", p. 36).

PLANNING STRATEGY

RENDEZVOUS WITH THE GOOD DRAGONS

If the PCs go to where they agreed to meet Kerrija and Terrilyn in case of an emergency, they find the dragon siblings waiting for them. If the PCs don't go or didn't agree on a meeting place, Kerrija and Terrilyn sniff out the PCs shortly after the appearance of the tower. (See the inside module cover for Terrilyn and Kerrija's statistics.)

Steel-Eye (11 a.m.) accompanies Terrilyn and Kerrija. (If the PCs didn't leave Steel-Eye on good terms, substitute Papian (Random Encounter 6) or Moonscale (Location 10), presuming the PCs met them previously and left on good terms.)

Neither the siblings nor Steel-Eye know the purpose of the tower. All three, however, recognized Artha; if the PCs are unfamiliar with her, Steel-Eye tells them what he knows (she is the daughter of Takhisis and Chemosh, she is the one responsible for the assaults on the city, and the good dragons have no intention of giving in to her demands). As before, the dragons reveal nothing about the secret portal, other than to say that it isn't in Cirulon.

Terrilyn asks the party if they know anything about the tower. If they tell the dragons about their dreams, Terrilyn and Kerrija become noticeably frightened.

Steel-Eye flew close enough to the tower to get a good look at it. He says the red dragon on top of the tower is the only enemy he spotted, "but there must be someone—or something—inside the tower to guide it." There is a human-sized door at the base of the tower, he adds, which appears to be the only entrance.

Steel-Eye suggests that the red dragon guard must first be destroyed, then the tower must be entered to stop whoever or whatever is guiding it. "Are you willing to help?" he asks the PCs. (If they aren't, see "Troubleshooting" at the end of the chapter.) Steel-Eye says they should make their plans quickly and asks for their suggestions.

USING THE DRAGONLANCE AND WINGS

The PCs may wish to take advantage of the *dragonlance* and the *dragon wings* at this time.

Dragon wings. In their initial encounter with Terrilyn and Kerrija, the PCs may have learned the purpose of the *dragon wings*; female characters may have already used them. If anyone spoke previously with the siblings about the *wings*, Terrilyn brings it up again and demands that her brother help out the male PCs. Considering the circumstances, Kerrija reluctantly agrees. The *wings* take effect as explained at 4 p.m. in the Chapter 1 Timeline.

Dragonlance. If the party discovered the *dragonlance* in the History Gallery (Location 14), they may wish to use it now against the red dragon guard. As much as Terrilyn would like to go into battle, neither she nor her brother will allow themselves to be used as mounts for the *dragonlance*, to honor their agreement with Tertullian. However, Steel-Eye (or Papian or Moonscale) will agree to serve as a mount.

If the PCs decide to use the *dragonlance*, they have to go to

the History Gallery to fetch it (unless they've been dragging it around with them). The dragons will give them a ride to the History Gallery; two PCs can ride each dragon.

The PCs must decide among themselves who will ride Steel-Eye and use the *dragonlance*. The *dragonlance* harness can be adjusted so two PCs can ride at the same time.

PLAN OF ATTACK

Steel-Eye listens to any suggestions the PCs have for attacking the tower, then offers his own, depending on whether the PCs have the *dragonlance*. If the PCs make one of the following suggestions, Steel-Eye agrees with them.

If the PCs have the *dragonlance*. Steel-Eye and his riders will attack the red dragon first. While the red dragon is distracted by the attack, Terrilyn and Kerrija will fly the remaining PCs to the tower entrance (or if using *dragon wings*, they can fly themselves). If victorious, Steel-Eye will drop off his riders at the tower entrance, bringing the party back to full strength to face whatever is inside. If defeated, the surviving party members will have to continue as best they can.

Terrilyn and Kerrija will follow from a distance, ready to pick up the PCs at the tower entrance and fly them to safety.

Steel-Eye and his riders may wish to work out tactics before going into battle (for instance, they might decide on a signal when they attempt to charge with the *dragonlance*).

If the PCs don't have the *dragonlance*. Steel-Eye will fight the red dragon alone. He will attempt to lure the red dragon away from the tower, at which time Kerrija and Terrilyn will shuttle the PCs to the tower entrance. Terrilyn and Kerrija will follow the tower from a distance, ready to pick up the PCs at the tower entrance and fly them to safety.

If the PCs devise a different plan, Steel-Eye still insists they use one of the above unless they can convince him (i.e., the DM) that their plan is better. Under no circumstances will Terrilyn or Kerrija fight against the red dragon. Steel-Eye discourages any flying PC from attacking the red dragon. (If they insist, the DM might point out to them how vulnerable a flying PC is against a red dragon.)

ATTACKING THE RED DRAGON

What happens here depends on whether Steel-Eye (or Papien or Moonscale) attacks alone or with riders using the *dragonlance*:

If attacking with riders. The **red dragon** senses Steel-Eye and his riders as soon as they fly into the air. The red dragon roars and launches herself, attempting to glide toward Steel-Eye and blast him with her fire breath. The dragon then circles and repeats this attack, after which she attacks with her claws and teeth, reserving her final breath weapon in case the battle turns against her. She tries to keep the battle in the air, although if Steel-Eye lands on the roof of the tower, she follows. The red dragon pursues if necessary and will fight to the death.

If any flying PCs ignored Steel-Eye's advice and attack the red dragon anyway, she ignores them in favor of her draconic opponent. If flying PCs inflict more than 6 hit points of damage in a single round, she roars at them and attempts claw and bite attacks until they retreat, after which she resumes her attack on the gold dragon.

If Steel-Eye wins, he lets his riders off at the tower entrance, wishes them good luck, then flies away to observe the movements of the tower from a distance.

If the red dragon is winning the battle or if the riders have lost more than half their hit points, Steel-Eye retreats, circles the tower, and lands near the tower entrance to let his riders

off, holding the red dragon at bay with his breath weapon if necessary. If the riders hesitate, Steel-Eye snarls and threatens to kill them if they don't get off. Steel-Eye resumes the battle against the red dragon on his own (a fight which Steel-Eye eventually wins).

If attacking without riders. Steel-Eye blasts the **red dragon** with his breath weapon, then hovers just out of range, forcing her to pursue. Steel-Eye successfully lures her far from the tower where they engage in a battle to the death (a fight which Steel-Eye eventually wins).

THE BLACK TOWER

The tower hovering over the city was originally a prison. It consists of four levels and an observation dome. The tower sits atop an immense chunk of rock which was uprooted when the enchantments from the evil mages and clerics caused it to rise. The entrance door to the first level is the only access to the tower.

The following also applies to the tower:

1. Powerful enchantments cause the tower to fly and will cause it to explode at 2 a.m. Flight is controlled from the observation dome. Artha has already set into motion the enchantment that will cause the tower to explode. Neither the flight nor the explosion enchantments are effected by *dispel magic* or similar spells.

2. The tower walls are stone, the floors and doors are wood. Unless indicated otherwise, all areas of the tower are dark. There are no windows. The interior of the tower is musty and humid. The rock chunk supporting the tower is warm to the touch and pulsates slightly, as if a heart were slowly beating inside. This is a side effect of the enchantment which will cause the tower to explode at 2 a.m.

3. Movement between levels is by rope ladders hanging from the higher level.

4. Make sure the PCs understand they have a fixed amount of time in which to stop the tower. As 2 a.m. approaches, the following effects occur:

11 p.m. The tower walls are warm to the touch.

Midnight. The temperature inside the tower rises to 90 degrees. The walls are becoming uncomfortably warm.

1 a.m. The tower walls are extremely hot; touching a wall with exposed flesh, such as a bare hand, causes 1 hp of damage. Sections of the wooden floor smoulder and smoke.

TOWER ENCOUNTER KEY (MAP 2)

The tower is square, 50 feet on each side. Each level is fifteen feet high, including floor and ceiling thickness. The observation dome is about 30 feet in diameter.

I. FIRST LEVEL

The first level of the tower was used to dispose of the bodies of dead prisoners.

1a. Entry Door. This narrow door is locked. If no one is able to *open locks*, a successful Strength Check from a single PC can break it down. Two PCs with a combined Strength of 20 or more can break it down without a Strength Check.

1b. Dark Corridor. At the northeast end of this corridor is a ladder leading up. Four rotting bodies slump against the wall near the ladder. These four **zombies** attack anyone they see, and fight until destroyed. They pursue if necessary, though they won't leave this level.





1c. Disposal Pit. The door to this room is locked, but it is damp and rotted. If no one is able to *open locks*, the door can be easily shattered with a successful Strength Check (+3 bonus) from anyone.

If the party opens the door, they are greeted with a nauseating stench of decay which billows into the corridor. Anyone within 10 feet of the door must make a successful Constitution Check or lose 1 hp of damage.

This room is dug out of the bedrock about four feet below the level of the corridor. Bodies of dead prisoners were dumped into this room through a trap door in the northeast corner of the ceiling. The room is filled with damp piles of refuse, debris, and other remains. The stench is so powerful that it causes the PCs' eyes to water.

Two **ghouls** are feasting in the southeast corner. If anyone enters the room, the ghouls sniff him out in one round. They stumble toward the PCs, excited by the prospect of fresh food. Each ghoul attempts to *paralyze* a PC, then drag him back to the corner for dinner. They fight to the death and pursue if necessary; they can easily break through the rotted wooden door. However, they will not leave the tower.

If the ghouls chase the PCs through the corridor (1b) and the zombies are still alive, the zombies join the attack. The ghouls and zombies will not attack each other.

If the PCs dispose of the ghouls, they can search for treasure. For every 10 minutes a PC searches the pit, there is a 50% chance he finds one of the following items (choose randomly): a steel good luck charm (worth 300 stl), a dagger, a leather pouch containing 42 gp, a *ring of feather falling*.

At the end of every 10 minutes of searching through the foul muck, the PC must make a successful Constitution Check, or lose 1 hp.

2. SECOND LEVEL

The second level was used to interrogate prisoners.

2a. Corridor. The hole in the northeast end of this corridor has a ladder leading down to the corridor in the first level (1b). Near this hole is a trap door with an iron ring. The trap door opens easily and leads to the disposal pit below (1c). In the southeast end of the corridor is a hole in the ceiling. The ladder leading up has been pulled through the hole. The end of the ladder can be seen through the hole; if anyone manages to hook it or grab it, he can pull it down. Unfortunately, the ladder is rotted and useless.

2b. Interrogation Room. The door to this room is unlocked. The room is illuminated by torches set in three iron holders on the exterior walls. Along the west and east walls is an assortment of manacles, chains, stone tables, braziers, and iron pokers, all used by the prison guards to interrogate prisoners. There is a ladder leading up to a hole in the ceiling.

A man in a black robe holding an oaken staff sits facing the center of the north wall, studying a huge glowing crystal imbedded in the wall. Two **zombies** stand motionless beside him. To the right of the crystal is a wooden table holding a wine bottle, a goblet, a stack of parchments, a blanket, a wooden chest, and a small iron chest.

This is **Crouse**, one of the evil clerics who helped design the tower for Artha. The glowing crystal is a *crystal of true seeing*, a stone permanently enchanted with *true seeing*. As the tower passes over each building in Cirulon, Crouse uses the *crystal* to determine if that building contains the portal to the plane of the Astral Dragon. Fluttering overhead, hidden in the shadows, are two **eyewings**. If Crouse should discover the location of the portal, he will tell the eyewings, who in turn will fly to Artha and tell her.

Crouse's identical twin brother, Kroghir, also an evil cleric, controls the movement of the tower in the observation

dome. The twins have a psychic link which allows them to communicate with each other mentally. In this way, Crouse informs Kroghir when he finishes checking a building.

Unlike Kroghir, Crouse knows that the tower is set to explode. He has no intention of telling his twin about this, as he hopes to claim Kroghir's share of the family holdings when his brother dies. Just before 2 a.m., Crouse intends to drink the *potion of flying* in the iron chest on the table, then escape through a secret door hidden in the west wall of the room.

If anyone opens the door, the zombies immediately alert Crouse. Crouse sees the intruder and panics. He orders the zombies and eyewings to attack while he cowers in the northwest corner.

The eyewings first attempt to drip tears on the party, then swoop low to attack with their claws and tails. Both the eyewings and zombies fight to the death.

Two rounds after the eyewings and zombies attack, Crouse gathers his courage and attacks with his *staff of striking*. He uses only one charge per attack (for 1d6+3 hp of damage, +3 to hit).

The zombies, eyewings, and Crouse will pursue the party into the corridor but will not leave this level. If the PCs escape to another level, Crouse figures that either the other monsters or the explosion will finish them off.

If two of the four attacking monsters are killed, Crouse decides to cut his losses and open the iron chest to drink the *potion of flying*. He then plans to open the secret door and fly away. It takes Crouse one round to open the chest and drink the potion, one round to open the secret door, and one round to make his getaway.

If the PCs nab Crouse, he begs for his life. At the slightest coercion, he tells about the *crystal of true seeing* and his mission in Cirulon; although he knows he's looking for a portal to another plane of existence, he doesn't know where the portal leads or why Artha wants to find it. He tells them that his brother, Kroghir, controls the tower's movement from the dome on top of the tower. If Crouse thinks the PCs might kill him, he tells them they're all doomed if they don't get out of the tower soon. "Feel the walls!" he whimpers. "They're getting warmer! We don't have much time!"

What to do with the captured Crouse is up to the PCs. If they let him go and allow him to keep his *potion of flying*, he drinks it and escapes out the secret door immediately. They could tie him up or lock him in the room across the corridor (2c). If they bring him along, he attempts to escape at the earliest opportunity—unless the PCs stop him, he runs to the disposal pit in the first level to search for the *ring of feather falling* he hid there for an emergency. If it is still there, he finds it in two rounds.

The PCs can take the wine, the *staff of striking*, and, if Crouse didn't drink it, the *potion of flying* (one dose). The wooden chest contains a week's worth of rations. Most of the parchments contain the awful poetry Crouse wrote to while away the time. One of the parchments is a crude map of Cirulon with six buildings circled (the Copper, Gold, Silver, and Brass Philosophy Galleries, the History Gallery, and the Council Chamber).

Anyone has his normal chance to find the secret door in the west wall, assuming Crouse hasn't already pointed it out. It is about 4 feet square, just big enough for an eyewing to squeeze through in case Crouse needed to inform Artha of the discovery of the portal. The door leads directly outside.

The *crystal of true seeing* is lodged securely in the stone wall. If the PCs manage to dislodge it, it shatters and loses its magical properties. The crystal shards have no value.

2c. Lock-Up. At one time, this room was a solitary confinement area. It now contains three **skeletons**.





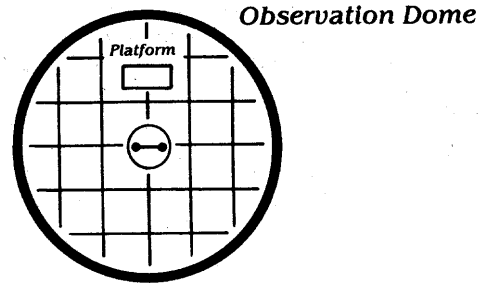
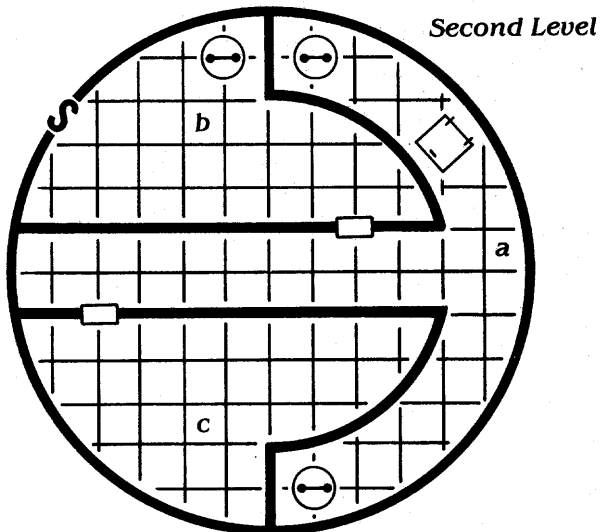
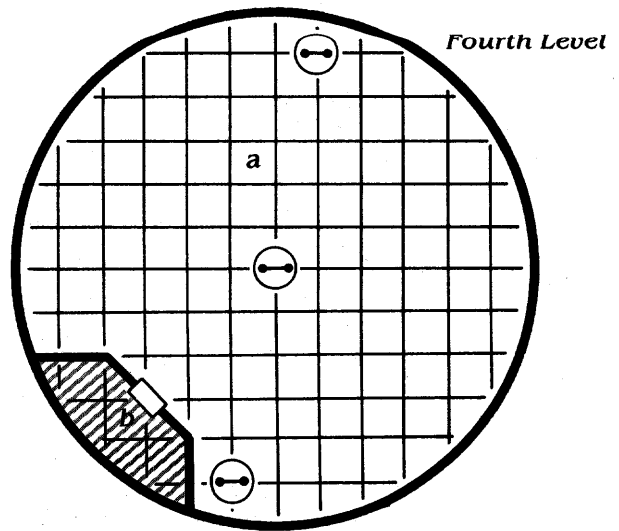
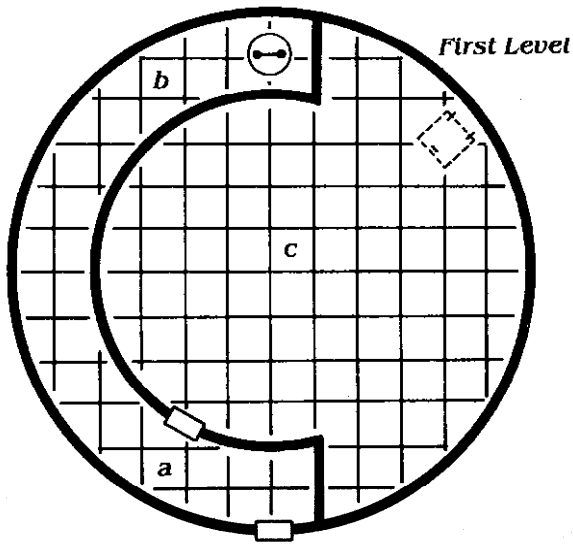

The door to this room is locked. If the PCs are unable to *pick locks*, it takes 20 hp of damage to break it open.

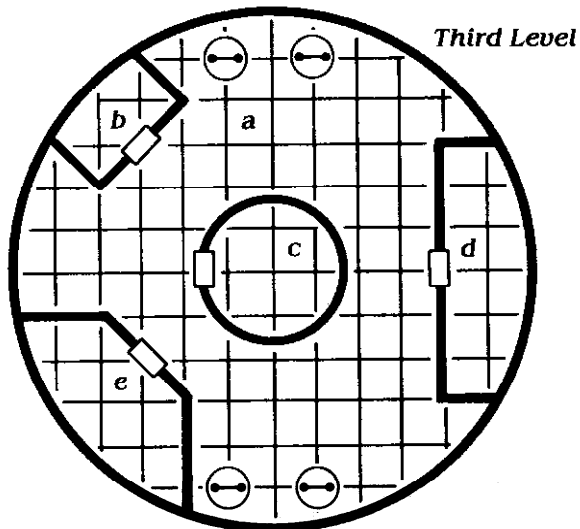



BLACK TOWER (Map 2)



-  Door
-  Ladder
-  Trapdoor in ceiling
-  Trapdoor in floor
-  Rotten flooring
-  Secret door

Each square equals 5 feet.

Each level is 15 feet high.

CENTRAL SCHALLSEA (Map 3)



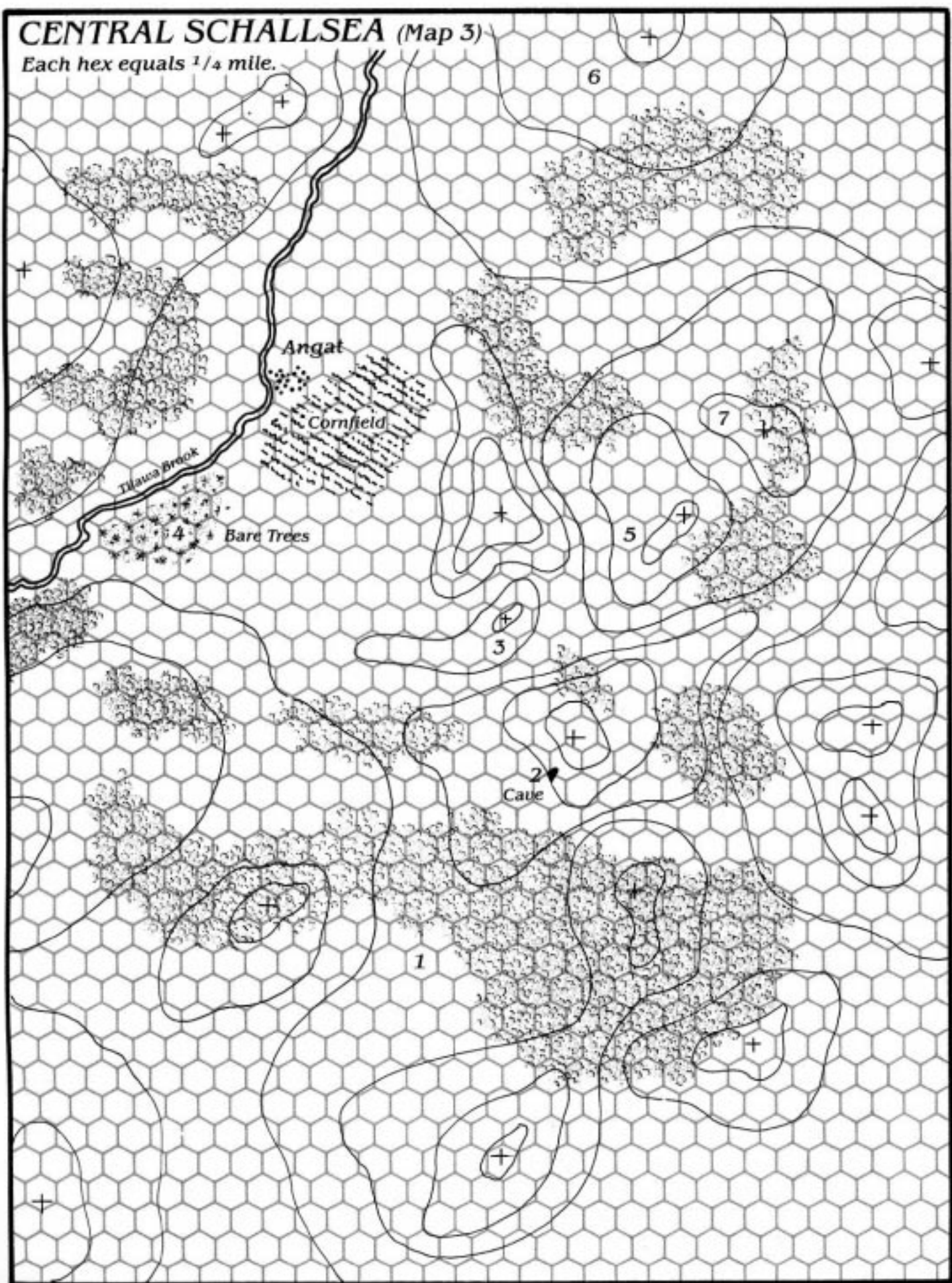



Each hex equals 1/4 mile.

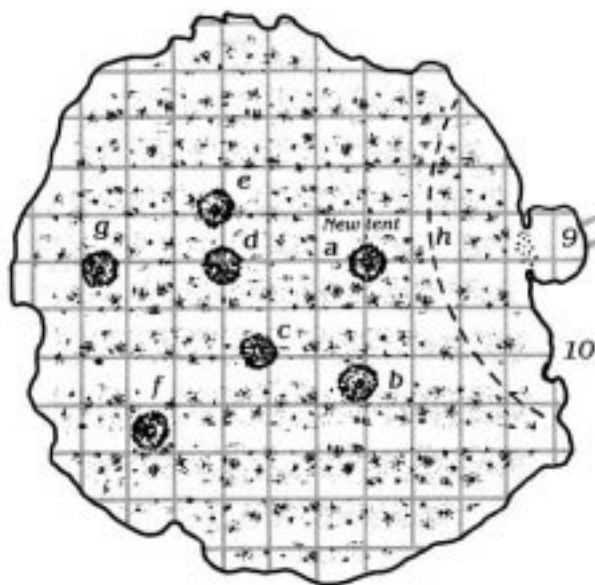



GARDEN OF THE DEAD (Map 4)



-  Crevasse
-  Sinkhole
-  Mud
-  Rubble
-  Cornfield
-  Mist entrance
-  Skeleton's path
-  Random Phenomena

Each square equals 10 feet.



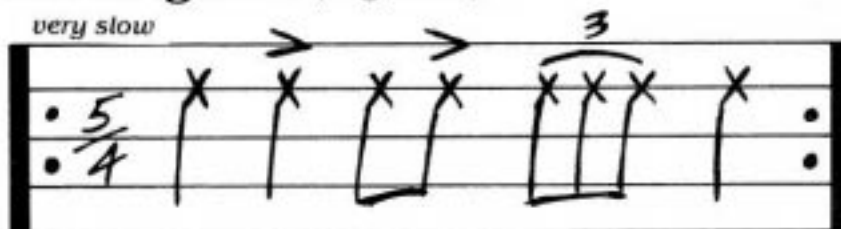

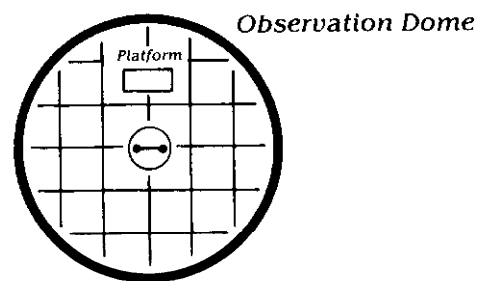
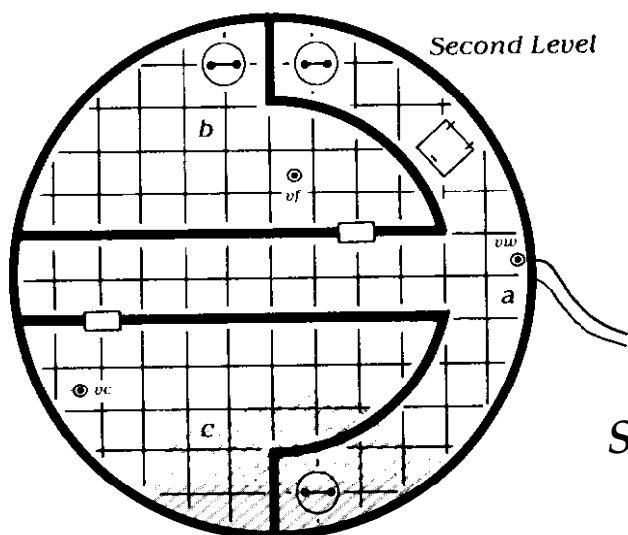
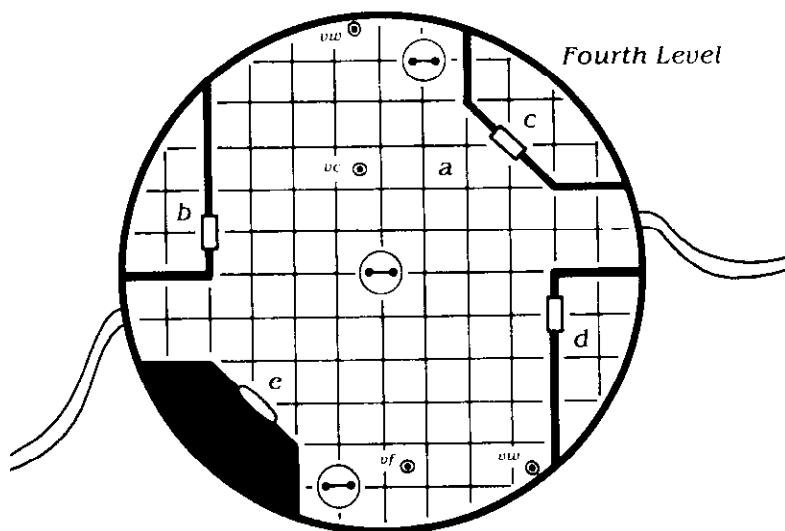
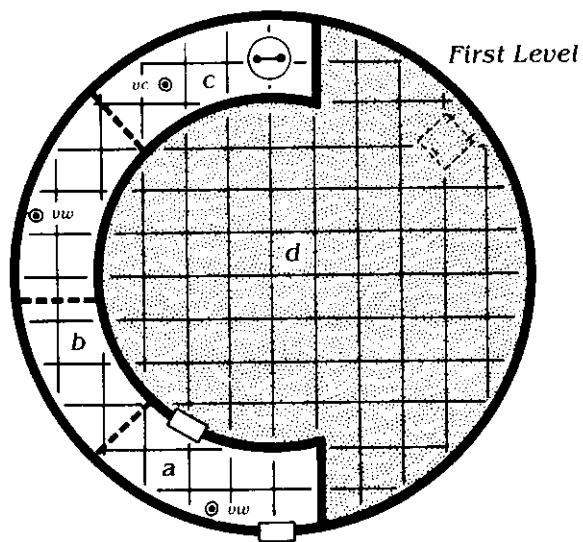

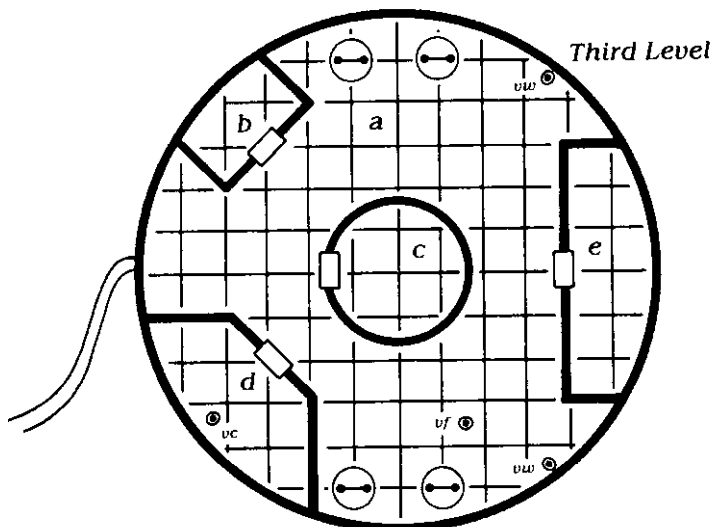

Undead Drum Rhythm (Figure 1)





SECOND BLACK TOWER (Map 5)



-  Door
-  Ladder
-  Trapdoor in ceiling
-  Trapdoor in floor
-  Spiracle
-  Tentacle en try point
-  Rotten flooring
-  Water
-  Vocal orifice
VF = in floor, VC = in ceiling, VW = in wall

Each square equals 5 feet.

Each level is 15 feet high.

moon Tracking Chart

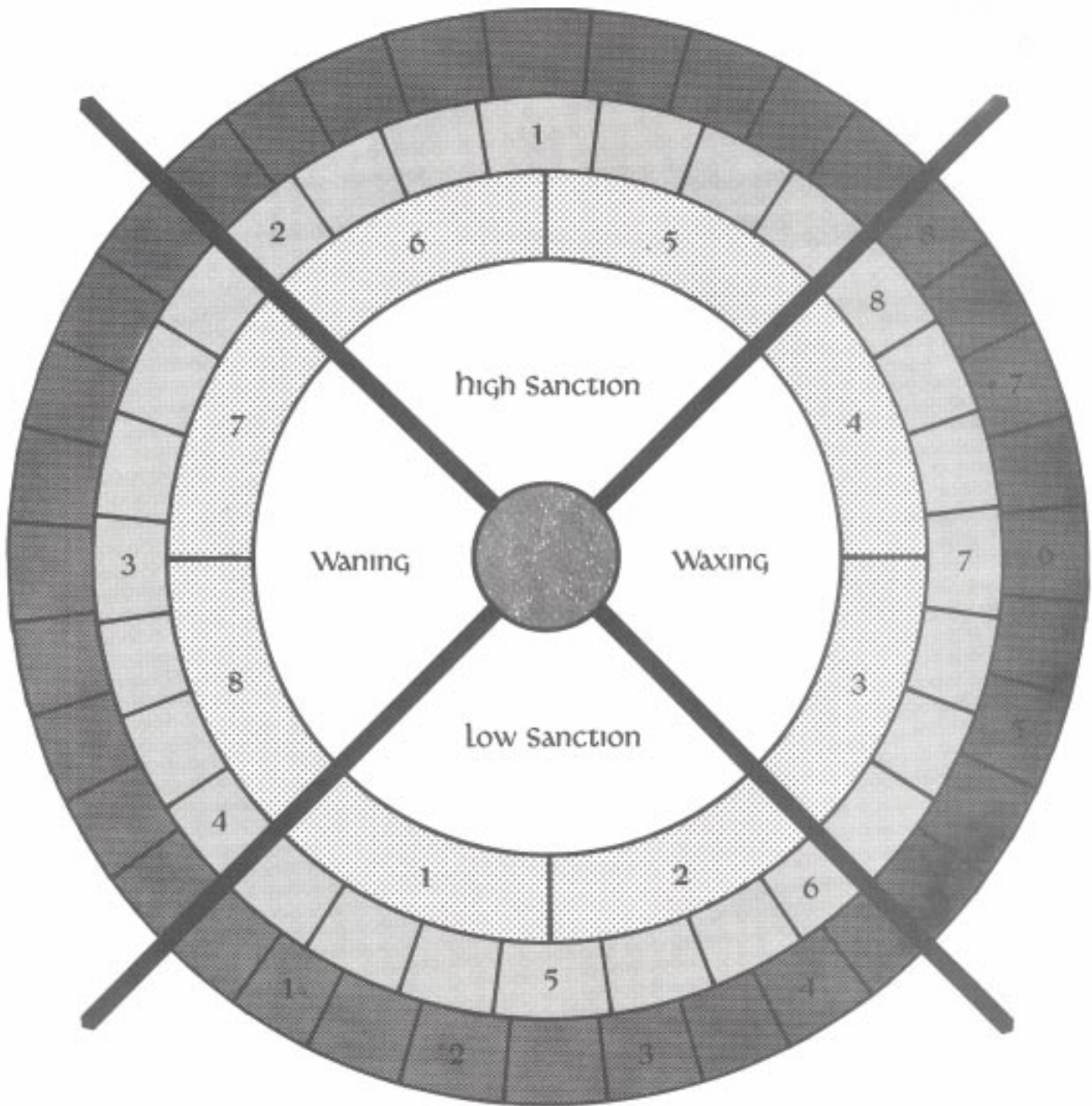

Solinari: Period of 36 standard days with 9 days per quarter.

Nutari: Period of 28 standard days with 7 days per quarter.

Lunitari: Period of 8 standard days with 2 days per quarter.

While the PCs are trying to open the door or if they are excessively noisy while in the corridor outside of this room, they hear scratching and clawing against the door, as if something inside was desperately trying to get out. If the PCs open the door, the skeletons lunge at them.

The skeletons will fight till destroyed, but will not pursue to a different level of the tower. If the PCs didn't break down the door, they can close it again, and skeletons inside will once more be unable to get out.

If the PCs defeat the skeletons, they can search the room. Shackles are imbedded in the exterior walls and straw and other refuse is strewn on the floor. A tiny diamond worth 3,000 stl is under an old blanket in the southwest corner.

3. THIRD LEVEL

This level contains the cells used to confine prisoners.

3a. Corridor. There are four exits from this level, two up and two down.

The southeast exit leading down has a rotted ladder coiled beside the hole in the floor. The ladder crumbles at the slightest touch.

Also in the southeast corner is a ceiling hole. A ladder dangles from this hole. However, the ladder is covered with a gray fungus that smells like old cheese. Though the ladder is sturdy, the fungus has permeated the rungs and the ropes holding them together. It is impossible to scrape the pasty fungus from the ladder.

A PC who steps on the ladder or touches it in any way sticks tight. A cup of any liquid, such as water or wine, frees a stuck hand or foot.

A ladder dangles down through the northwest floor hole. This leads to the interrogation room (2b).

A ladder also dangles from the northwest ceiling hole. The top half of this ladder is covered with yellow fungus. Anyone who touches it (or is within five feet when it is disturbed), and fails to save vs. poison, suffers 1d4 hp of damage and sneezes incessantly for the next hour.

3b. West Cell. This cell is one long room enclosed with iron bars. It contains a half-dozen wooden buckets, a half-dozen cots, and a garbage pile against the north wall. The door is unlocked.

There is nothing of value here.

3c. Solitary Confinement. This windowless room has stone walls, a stone ceiling (10 feet high) and a heavy, locked wooden door. If the PCs are unable to *pick locks*, they must inflict 20 hp of damage to break it open.

This room was used to confine unruly prisoners. It now contains an **ochre jelly**.

The ochre jelly clings to the ceiling, dropping as soon as anyone enters. If the door is opened but no one enters, the jelly drops to the floor and gives chase anyway, seeping under the door if it is closed again.

The ochre jelly fights to the death, pursuing to any level, traveling along the walls and following through ladder openings if necessary.

If the PCs search this room, they find a flask of *oil of slipperiness* (one dose).

3d. East Cell. The contents of this cell are similar to those in the west cell—cots, buckets, and a garbage pile against the north wall. The door is unlocked.

A nest of **rats** lives in the garbage pile.

If the PCs disturb the garbage pile, the rats scamper in every direction. There is a 20% chance that anyone standing in the cell will be attacked by a panicking rat; however, the rat attacks only once before running away. If a rat is trapped or cornered, it fights ferociously. Otherwise, the rats find hiding places and vanish two rounds after their nest is disturbed.

If the PCs examine the garbage pile, they discover a red silk

sash; if cleaned up, the sash is worth 10 stl.

3e. South Cell. The contents of this cell are similar to those in the west cell—cots, buckets, and a garbage pile against the south wall. The door is locked. However, this cell also contains four **skeletons**. As soon as the skeletons see the PCs, they begin to shake the bars, extend their bony arms, and rattle their bones to attract the party's attention, hoping they will be set free.

If the PCs want to open this cell and are unable to *pick locks*, they can try to pry the rusty lock open. It requires a Strength Check at a -2 penalty and something to pry with, such as an axe. If two PCs pry together, the PC with the highest Strength makes the Strength Check at no penalty. While the PCs attempt to open the lock, the anxious skeletons claw and grope at them.

If the PCs are foolish enough to open the lock, the ungrateful skeletons attack. They fight until destroyed, although they will not pursue the PCs to a different level.

4. FOURTH LEVEL

This level contains the living quarters for the prison guards, and a storage area.

4a. Barracks. This entire area is filled with a jumble of debris—broken chairs, shattered tables, filthy blankets, and shredded bed rolls. Four **zombies** stumble aimlessly amid the garbage.

At one time, this area was divided into several living quarters for the guards, with each section separated from the others by wooden partitions. However, four zombies were assigned here to protect Kroghir (in the dome) from intruders. Under orders to kill any living thing, the zombies disturbed a nest of rats and demolished the entire area in their efforts to kill them.

As soon as the PCs enter this area, the zombies attack. The zombies fight until destroyed, but they will not leave this level. They will, however, follow into the storeroom (4b).

In the southeast corner is a floor opening. A ladder dangles from this hole. The ladder is covered with a gray fungus that smells like old cheese. A ladder also dangles through the floor opening in the opposite corner. The top half of this ladder is covered with yellow fungus. For the two fungus effects, see their description in 3a), above.

An opening in the center of the ceiling leads to the dome. No ladder dangles from this opening. (If the PCs pile up some of the junk in the room, they can make a stack high enough to climb through the opening.)

If the PCs dispose of the zombies, they can search the area more thoroughly. For every 5 minutes someone spends searching, there is a 50% chance he finds one of the following items (choose randomly): key ring (the keys open all the locked doors in the tower), short sword, quiver with 12 arrows, dead rat, *shield +1*.

4b. Storeroom. The storeroom has stone walls and a splintered door. The room smells of rotten grain.

The wooden floor is extremely rotten. Anyone stepping on it has a 75% chance of falling through. If he succeeds in a Dexterity Check (at -1), he catches himself before falling all the way through. Anyone who falls through the floor lands in the south cell of the third level (3e). If the skeletons are still there, they attack and fight until destroyed.

There is nothing of value in the storeroom.



5. OBSERVATION DOME

Read the following if the PCs enter this area:

In the center of this room is a raised platform holding two 3-foot-tall pedestals 3 feet apart. A glowing black globe sits atop each pedestal. There are two black disks between the pedestals. Crouse (from 2b), or a man who looks and is dressed exactly like him, stands on the disks, his hands on the globes. A curtain of light rising from the platform surrounds the man. The domed ceiling glows in a soft light and is etched with strange symbols.

This is the control room for the flying tower. The man at the controls is **Kroghir**, one of the evil clerics who designed the tower for Artha, and the twin brother of Crouse. The curtain of light surrounding him is a *wall of force*, activated when the tower pilot stands on the black disks. The glowing ceiling is a map of Cirulon and the surrounding air.

Kroghir and his brother share a psychic link which allows them to communicate mentally. Kroghir guides the tower from one building to the next while Crouse examines each with the *crystal of true seeing*, looking for the portal to the plane of the Astral Dragon. However, unlike Crouse, Kroghir is unaware that the tower is set to explode, as he did not participate in this part of the original enchantment of the tower. When he finishes checking all of the designated buildings, Kroghir has been instructed to hover the tower over the Council Chamber and await further orders from Artha.

If the PCs speak to Kroghir through the *wall of force*, he ignores them. If they destroy the *wall* (a *disintegrate* or similar spell would do it), he panics and mentally summons Crouse for aid. Even if Crouse is still in the tower, he ignores him. Kroghir doesn't bother putting up a fight; instead, he uses his *helm of teleportation* to abandon the tower.

If the PCs can't destroy the *wall of force*, they can attract Kroghir's attention by telling him that Crouse is gone. Kroghir will confirm this mentally (presuming that Crouse has indeed left), then panic and *teleport* out of the tower.

If Crouse is still in the tower and the PCs can't destroy the *wall*, Kroghir continues to ignore them. They can either abandon the tower to rendezvous with Terrilyn and Kerrija, or they can wait. As 2 a.m. draws nearer and the tower gets hotter, Kroghir becomes increasingly concerned. Just before 2 a.m., Kroghir panics and *teleports* to safety.

Once Kroghir is gone, the PCs can attempt to operate the tower. The *wall of force* is gone until someone else steps up to the controls. The tower responds to the mental or spoken commands of its pilot. Someone must stand on the black disks, place his hands on the globes, then think or speak the direction and speed he wishes the tower to travel. The tower can travel in any direction, including up and down, and can move at speeds up to 10 miles per hour (1000 feet per minute). This tower continues to move in the same direction and speed until given another order, even if the pilot leaves the controls. (For instance, if the pilot ordered the tower to leave the city at top speed, the tower would carry out its orders even after the pilot left.)

Once Kroghir *teleports* away, he will not return. Crouse will not enter the dome under any circumstances.

EXPLOSION

If the PCs abandon or complete their mission in the tower before 2 a.m., they can rendezvous with Kerrija and Terrilyn at the tower entrance and fly to the safety of the closest Den-

sity 3 building. If the PCs don't rendezvous with the siblings, they can go wherever they like. (If the PCs have problems getting out of the tower on time or seem determined to stay inside the tower, see "Troubleshooting" at the end of this chapter.)

When 2 a.m. arrives, the black tower begins to vibrate. Chunks of the rock base crumble and drop off. If anyone is still inside, he has 30 minutes to get out before the wooden floors burst into flames; five minutes later, the tower explodes in a ball of fire. (The enchantment causes the tower to act as a momentary conduit to a hellish plane of the Abyss, drawing in hellfires of awesome power and magnitude.)

If the PCs were able to send the tower away from the city, the explosion is seen in the distance as a blossoming fireball, momentarily bright as the sun before it collapses in a cloud of black ash. If the tower explodes at least a half-mile (2500 feet) from Cirulon, the city takes no damage.

There will be damage to Cirulon if the tower explodes nearby. The ball of flame extends in a half-mile radius from the tower. All Density 2 structures within this radius collapse into rubble. Density 3 structures are unharmed. All monsters and characters out in the open are vaporized (the good dragons still in Cirulon all took shelter in a building). If the party hid in a Density 3 structure, they take no damage. If they hid in a Density 2 structure, they take no damage from the flames, but the structure collapses on them, and each suffers 2d10 hp of damage.

AFTERMATH

Within minutes after the tower explodes, the sky clears and the air becomes still again. If the tower exploded over the city, its black ashes sprinkle to the ground below.

As soon as the sky clears, a rainbow appears under the stars, a band of shimmering colors about 50 feet wide extending over the city from one side to the other, glowing softly and radiating *protection from evil*. (This is identical to the rainbow described at 4 p.m. in Chapter 1.) The rainbow lasts for an hour, then fades away. This is the first time in Cirulon's history that the rainbow has appeared at night, and the good dragons take it as a sign that the assaults on their city have finally ended.

If the PCs are with Kerrija and Terrilyn, the dragons suggest they survey the damage to the city. If the PCs are on their own, Kerrija and Terrilyn join them shortly after the rainbow appears to see if they're well.

After a few minutes outside, a small brass dragon can be seen circling over the city. If the PCs don't notice the brass dragon, Terrilyn points it out. "Oh no," mutters Kerrija. "This is just what we need." He doesn't elaborate, but tells the party to wait.

The brass dragon flies closer, then circles above the party. "We'll be right back," sighs Kerrija, then to Terrilyn, "Let's go."

Kerrija and Terrilyn flap up to the brass dragon. The three dragons land on top of a nearby building. They engage in a brief discussion, then the brass dragon flies away. Kerrija and Terrilyn return to the PCs.

"That was **Trillum**," explains Kerrija. "He is the son of Strato, the brass dragon member of the Council of Cirulon, and serves as the Council's messenger. They want to talk with you." Kerrija says he doesn't know what the Council wants, but that he and his sister are supposed to make sure they appear at the Council Chamber at dawn. "I don't think it's anything to worry about," says Kerrija, not too convincingly. "Whatever you do, just don't lie to them!"

If the PCs ask about the Council, Kerrija explains that it consists of a wyrm of each good color, who oversee and reg-

ulate the affairs of Cirulon. Membership on the Council is passed within a family; either he or his sister will eventually replace Tertullian, their great-great grandmother.

If the siblings' dome (Location 18) wasn't destroyed by the tower, the siblings invite them to spend the night there. Otherwise, they will all have to sleep in one of the remaining buildings. If anyone requests it, Terrilyn is glad to explain to them the significance of any of the city's remaining art works that she understands (she has a 1 in 4 chance of understanding any particular piece). Kerrija says he's tired and needs to rest. "You're always tired," scolds Terrilyn, but her words fall on deaf ears.

At dawn the next day, Terrilyn and Kerrija accompany the PCs to the Council Chamber (Location 21). The door opens automatically when they approach. Kerrija and Terrilyn are not allowed inside. They wish them luck before they go. "Remember," whispers Terrilyn. "Tell the truth!"

THE COUNCIL MEETING

ABOUT THE COUNCIL

Now that the Council of Cirulon believes the threat to the city is over and the secret of the portal is still safe, they intend to assess the character of the party, to determine if they can be trusted to fulfill an important quest (explained in "The Verdict", p. 39).

For some time, the Council has been discussing the merits of the good people of Krynn. Currently, there are two factions on the Council. Alcuin (gold) and Anaximander (bronze) believe that good people should be trusted. Strato (brass) and Spir (copper) do not believe so. Tertullian (silver) remains undecided.

Prior to staging the next part of this adventure, the DM should review the Council members' personality notes to help role-play the dragons when they interrogate the PCs.

Alcuin is extremely powerful, but believes that intellect is a much more admirable quality than strength. He has great respect and admiration for intelligent creatures, regardless of their species. He loves nothing more than philosophic debates and will gladly spend days at a time engrossed in discussions with like-minded scholars.

He carefully weighs everything said, asking for explanations if statements aren't clear. He is only interested in facts and is unmoved by emotional pleas.

Anaximander is compassionate and trusting. She feels that there are things that can only be known with the heart, and hence distrusts those who base decisions entirely on facts. Alcuin is her closet friend on the Council, although their personalities could not be more different. She is Alcuin's favorite debating partner, a recreation she endures more than enjoys.

She believes wholeheartedly that the party is not responsible for the acts of anyone other than themselves. She has already decided they are trustworthy and is willing to give them the benefit of the doubt regarding any alleged indiscretions.

Strato is quick-tempered and gruff, but he is devoted to the Council and would not hesitate to give his life for any of his fellow Council members. Like Spir, Strato accepts the inferiority of all non-dragons as an indisputable fact. He is an art connoisseur and spends all his free time studying in the galleries of Cirulon.

He believes the bond between the good people and good dragons has already been irrevocably shattered. There is little the PCs can say to change his mind. Unlike Anaximander, he holds the party responsible for the actions of all good people of Krynn.

Spir is kind, but arrogant, utterly convinced that dragons

are superior in every way to all other creatures, humans included. She sees the bond between good dragons and good people as an unfortunate necessity. She prefers solitude to associating with other dragons, though she takes her responsibilities on the Council very seriously.

She is more compassionate than Strato, but believes there is too much at stake to trust people at this time. Though she makes an effort to be fair, she is very conservative and will not easily change her mind.

Tertullian is sensitive, thoughtful, and quiet. She seldom makes a decision without extensive meditation and prayer, believing the gods hold the answers to all problems. She believes the bond between good dragons and good people is a sacred principle of the gods, and thus takes it very seriously. She further believes that dragons and people are equal in the eyes of the gods.

She has sought guidance in this matter from the gods, as she does for all things. So far, her prayers have gone unanswered, and she is unsure of whether or not to trust the party. She listens carefully to both questions and answers, but remains silent during the entire inquiry.

All of the dragons hold the truth in high regard and observe the party closely for signs of falsehood. If the PCs are evasive or offer feeble justifications for a questionable action, the dragons interrogate them relentlessly to reach the truth. (You might want to discourage PC lying by reminding them that the dragons can eventually find out the truth anyway from their spells and their *disks of history*.)

INTRODUCTIONS

The council chamber (Location 21) is a single room with a domed ceiling covered with a map of the celestial realm. The room contains six nests made of fluffy clouds. Five of the nests are identical in size and are elevated about 50 feet. A metal frame enclosing the nest identifies its owner—gold, silver, bronze, copper, or brass. The sixth nest rises 60 feet from the floor and is enclosed by a clear crystal frame.

Huge dragons lounge in the metal nests. The crystal nest is empty.

The door closes behind the characters. "Come forward," says the gold dragon politely, in a deep, grating voice. "Stand before us."

Once the PCs move into the center of the room, the gold dragon introduces himself as Alcuin. He then introduces the rest of the council: Anaximander (bronze), Strato (brass), Spir (copper), and Tertullian (silver). Alcuin asks the PCs for their names and their homes, and after they've responded, he continues.

"The evil forces intent on destroying Cirulon have retreated, at least for now," says Alcuin. "Your help in the defense of our city has been appreciated. But that is not why we have called you here."

Alcuin says that since the beginning of time, a sacred bond has existed between good people and good dragons. He asks if they know about this bond. If not, he explains that when the bond is threatened by doubt, disrespect, or dishonor, both good people and good dragons suffer and regress. But when the bond is strong, they flourish and prevail.

"When the people of Krynn were threatened with destruction in the War of the Lance, we were there to help," continues Alcuin, "Many good dragon lives were lost so that Krynn could resist the forces of evil."

"But since the end of the war, the good people of Krynn have turned their backs on us. Many of us are persecuted and exploited on the world we share together. There is doubt whether the bond between us can ever be strong again."

"We ask your patience and your honesty. If you have questions of your own, they will be answered later." (The dragons



strictly enforce this; if the PCs interrupt the dragons with questions, the dragons refuse to answer until the end of the meeting.)

THE COUNCIL'S QUESTIONS

"So what do you think of all this?" sneers Strato to a random PC, in a high-pitched creak. "I assume the bond Alcuin speaks of is so much nonsense to you." Whether the PC hesitates or begins to answer, Strato ignores him and addresses another random PC. "And how about you? Do you deny that your people have exploited us, even hunting us down like dogs?" If the PC hesitates, he addresses another. "Speak!" he bellows. "I demand an answer!"

After the PC replies, or if he is having trouble coming up with an answer, Anaximander breaks in, speaking to Strato. "It is unfair to hold these people responsible for the actions of their respective races," she says. Her voice is breathy and barely audible, but it commands attention. "The very fact of their presence here today demonstrates good faith. It is up to us to reward that faith with trust."

"No," says Spir softly, in wonderful tenor tones. "There is too much at stake. How can we afford to risk betrayal?"

"This is a waste of time!" snorts Strato. "Send them back to their foul little cities and let them kill each other!"

Anaximander and Strato begin to argue, but Alcuin stops them. "We brought them here to speak," Alcuin says. "It is time to listen."

Alcuin politely asks the PCs to give the Council examples from their own experiences that demonstrate how they have strengthened the bond between themselves and good dragons—how they have helped good dragons, fought with them, defended them, or worked with them.

The PCs' examples might include working with Steel-Eye and the silver dragon siblings to stop the black tower, helping the wounded Papien (Random Encounter 6), or fighting the evil minions they discovered in the city. (They could also offer examples from the first adventure, if they participated in it. Such examples could include fighting with the good dragons at the Peak of Clouds, accompanying Saramber to the dragon graveyard, or saving Thyron from the ogres.)

In each example, the dragons will press for details. Alcuin wants to know all of the facts but is not interested in the PCs' opinions. (For instance, if the PCs say that the black tower would have destroyed Cirulon without their help, Alcuin rejects their opinion as unsubstantiated speculation.) Strato probes for exaggerations and outright lies ("How do we know you didn't enter the black tower just to rob it?"). Spir is condescending ("That was very brave . . . for a human."). Anaximander is supportive ("Your actions were admirable. No dragon could have done more.").

If the PCs can produce three examples, Alcuin says their evidence is sufficient to satisfy the Council. If the PCs come up with fewer than three examples, Alcuin politely says that the Council requires more evidence. If the PCs are unable to produce any more examples, Strato grunts in disgust. "I think their deeds—or lack thereof—speak for themselves," he says. "Is it necessary to continue?" Alcuin ignores Strato and proceeds.

Next, the dragons ask the party a series of questions pertaining to specific actions they may have taken in Cirulon. The dragons are primarily looking for evidence of the PCs' honesty. Alcuin asks the questions; any PC can answer. (The DM has the option of expanding or shortening this list. In particular, he should eliminate any question that clearly doesn't apply to the PCs' experiences. For instance, if the PCs didn't find the *dragonlance*, there's no need to ask the first question. If the PCs didn't take any jewels, skip the second question.)

Why did the PCs steal the *dragonlance* from the Armament Repository? The dragons accept any answer pertaining to the PCs' efforts to defend the city. Otherwise, Strato is quick to accuse them of being common thieves and demands further explanation.

Why did the PCs steal jewels from the Treasure Dome? Spir points out the jewels belonged to Cirulon, not the PCs. "How are thieves punished on Krynn?" she asks. The only acceptable answer as far as the dragons are concerned is that the PCs didn't honestly know that the jewels were part of the city's treasure. Strato demands the return of any stolen jewels and an apology.

Why did the PCs attempt to steal an art object? If they attempted to steal anything from a gallery, the dragons demand to know why. Anything short of a full apology is unacceptable to the dragons. Spir also curiously asks of what use the art objects would have had for them on Krynn.

Why did the PCs agree to attack the tower? Strato thinks they wanted to steal it. Spir wonders why people would be so willing to sacrifice themselves for dragons. Alcuin asks them what made them think their strategy would work.

Why did the PCs run from a fight? This question refers to any instance where the PCs retreated rather than fight a minion (such as the sphinx, the homunculi, the imp, or any other monster). The dragons are looking for evidence of cowardice.

Why did the PCs hesitate to trust Steel-Eye? Why did they refuse to help Papien? Again, the dragons are looking for evidence of cowardice. If the PCs encountered but refused to help the wounded Papien, Strato makes no effort to conceal his contempt.

Why did the PCs disturb the art works? Since many of the dragon art works could have potentially harmful effects on the PCs, the dragons want to know if the PCs were motivated by foolish curiosity. Strato demands to know who gave the PCs permission to enter the galleries in the first place, let alone disturb the art works.

After this round of questions, Alcuin asks the PCs if they have anything else they'd like to add. If not, the PCs may ask questions of the dragons before the meeting adjourns.

QUESTIONS FROM THE PCs

If the PCs ask the right questions, the dragons respond as follows. Alcuin speaks for the dragons.

Where did this city come from? What is it for? "Cirulon was a gift from the gods of good. It is used as a sanctuary for good dragons and also as a repository for some of our most treasured works of art. Our art preserves and records the most important aspects of our past."

Who is responsible for the attacks on Cirulon? How did they get inside the protective wards? "The attacks were led by a dark goddess named Artha, the offspring of Takhisis and Chemosh. Months ago, Artha and Khardra, a draconian enhanced by dark forces, engaged in ceremonies which absorbed light from the moons and stars, causing the protective aura of Cirulon to weaken. However, with Khardra's recent defeat, light is returning to the heavenly bodies and Cirulon's aura is growing strong once more."

What is the portal Artha is looking for? "The good dragons' greatest secret." (Alcuin won't elaborate.)

Who is Saramber? "A revered silver dragon who gave her life in the defense of the good dragons of Krynn."

Who is Abriele? "A friend." (Alcuin won't elaborate.)

Who does the empty Council seat belong to? "Visitors." (Alcuin won't elaborate.)

What is the disease infecting the silver dragons? "We don't know yet."

Why have so many dragons gathered at the Isle of

Dragons? Why so many at Lunitari? (The PCs may have deduced this from examining the Map Room, Location 13). Alcuin says nothing.

ADJOURNMENT

When there are no more questions, Alcuin announces that the Council will adjourn and reconvene in two hours. During that time, it will review the testimony. Alcuin gives the party permission to further explore the city with Kerrija and Terrilyn as their guides.

The silver siblings are waiting for them outside the Council Chamber. Terrilyn eagerly questions them about the meeting. She will take the PCs anywhere in the city, explaining the significance of any art works she understands (she has a 1 in 4 chance for each work). Kerrija excuses himself to get some rest.

THE VERDICT

When two hours pass, Terrilyn and Kerrija return them to the Council Chamber. Once the door closes, Alcuin announces that although some doubt remains as to the overall trustworthiness of the good people of Krynn, the Council accepts that the intentions of the PCs are good. (If the PCs performed badly in the inquiry, see "Troubleshooting" at the end of this chapter.)

"I cast the deciding vote," says Tertullian, speaking to the PCs for the first time, in a voice which sounds surprisingly human. "I hope I have not misjudged you, for I am about to ask you to undertake a perilous mission on my behalf."

Tertullian says that she recently experienced a dream which may hold the key to a cure for the fatal disease inflicting the silver dragons. "I saw the Wemitowuk, a primitive tribe who have never left the island of Schallsea. I saw the Wemitowuk leader wearing the hide of a silver dragon, spotted with the purple bruises symptomatic of the dread disease. I saw a silver dragon in the death throes of the disease. And then I saw the hand of a Wemitowuk spirit touch the dragon. The spirit's touch cured him."

Tertullian and the other Council members have no explanation of the dream. They do know that no dragons, silver or otherwise, have lived on Schallsea for centuries. Tertullian does not know the source of the dream, a fact which troubles her greatly. (For more about the source of the dream, see Chapter 4.)

Tertullian asks the party to journey to Schallsea to investigate the dream and discover the truth about its suggested cure. "I ask this on the strength of the bond that binds us and for the souls of the many whom the disease is claiming as victims."

Presuming the PCs agree to help, Alcuin says Terrilyn and Kerrija will accompany them to Schallsea. "They have never been beyond the borders of Cirulon," he says. "This will add to their experience, and they might be able to help you, as well." Tertullian nods in agreement.

The party leaves for Schallsea at dawn tomorrow, following a solid rest. In the meantime, they may remain in the company of Terrilyn and Kerrija. They have the freedom of Cirulon with the siblings as their guides.

REWARDS

Before the PCs leave the Council Chamber, the dragons present them with gifts as thanks for their help and to aid them in their upcoming mission.

Whether they receive all of the gifts is up to you. If they answered the Council's questions honestly and gave three examples of working with good dragons, award them all of the gifts. If they were occasionally elusive, but otherwise honest and gave three examples of working with good dragons, award all but the last. If they were elusive and could give only one or two examples, award all but the last two. If they were hostile, lied more often than they told the truth, and had committed a blatant offense (such as stealing an art object), don't award anything.

The gifts:

— any of the remaining weapons from the Armament Repository (Location 19), except the *dragonlance* (one weapon per character).

— 10 jewels per PC from the Treasure Dome (choose the jewels randomly from the mix given in Location 9).

— a *long sword* +1, +2 vs. *magic-using and enchanted creatures*, a *bastard sword* +1, +2 vs. *undead*, a *dagger* +2, +3 vs. *creatures larger than man-sized*.

— an *amulet of life protection* (one per PC).

TROUBLESHOOTING

Here are some tips for handling unexpected problems:

If the PCs can't be convinced to assault the tower. Have them visited again by the spirit of Saramber and experience the images of destruction from the Prologue. Make the images more intense if necessary.

If the PCs are on the verge of being destroyed in the tower. You may want to give the PCs a break if they've fought the good fight but are too slow or preoccupied to get out of the tower on time. Make it clear from the smoldering floors and red-hot walls that something awful is about to happen. If the PCs still have to make it all the way down from the observation dome to the first level and time is running out, you might want to pave the way by making the zombies and other monsters victims of the heat.

If the PCs performed poorly in the Council inquiry. The dragons send them on the mission to Schallsea anyway, as one last opportunity to prove their worth.

If the PCs don't accept the mission to Schallsea. Remind them that it could affect the relationship between the good dragons and good people for years to come. Rejecting Tertullian's request could be taken as a rejection of the sacred bond between good dragons and good people.



CHAPTER 3: GARDEN OF THE DEAD



DM's OVERVIEW

This chapter begins immediately after the events in Chapter 2. Use Maps 3 and 4 in the center pull-out section for reference.

In this chapter, the PCs should:

- discover the origin of the mysterious disease afflicting silver dragons, and
- discover a cure for the disease.

This chapter takes place in central Schallsea, an island in the New Sea between Abanasinia and New Coast. Schallsea is surrounded by rocky coasts and treacherous coral reefs which have discouraged contact from the rest of the world. The rich, black soil of central Schallsea makes it one of the most fertile areas in Ansalon.

Central Schallsea is blessed with generous rainfall and moderate temperatures. It is a region of rolling green hills, lush forests, and thriving vegetation.

DM's BACKGROUND

A thousand years ago, the primitive Wemitowuk tribe shared the island of Schallsea with a sizeable population of silver dragons. The relationship was not peaceful. The Wemitowuk were fearless, vicious warriors who preyed relentlessly on the dragons; their flesh provided food, their hides furnished tent covers and clothing, and their organs were used in religious ceremonies. Mounted on emre, ostrich-like birds capable of short burst of flight, skillfully wielding razor-sharp spears, the savage Wemitowuk outmatched even the

mighty dragons. Too proud to leave the land of their ancestors, the dragons' number gradually dwindled while the Wemitowuk tribe thrived.

Rule of the Wemitowuk passed from father to son. When the young Talawillona became chief, he presented his people with a radical proposal. The dragons are not animals for us to do with as we wish, he said, but an intelligent race worthy of our respect. Further, it was unnecessary to hunt dragons for food when fields of fruits, grains, and vegetables were theirs for the taking. "Let us change our ways and learn to live in harmony with the dragons," he said. "for surely that is what the gods intended when they placed us here together."

Chief Talawillona's proposal was soundly rejected. The gods placed the dragons here, said the tribal elders, for the use of the Wemitowuk and for no other reason. Talawillona was unmoved; as chief, he demanded that the tribe adopt his word as law. The tribe rebelled. Chief Talawillona persisted and ultimately was branded a heretic and expelled from the tribe.

Talawillona's crusade to save the dragons grew into an obsession. He appealed to the gods of good for help, but his prayers went unanswered. Frustrated, he turned to the gods of evil and was answered by Chemosh, the Lord of the Undead. Talawillona promised Chemosh access to the Wemitowuk sacred burial grounds if he would arrange it so that the Wemitowuk left the dragons alone. Chemosh agreed. After stealing a few choice souls from the burial grounds, Chemosh inflicted the silver dragons with a deadly magical virus. He'd kept his word—the Wemitowuk refused to go near the purple-stained dragons—but the dragons began dying in agony.

Chief Talawillona begged the gods of good to intervene and save the dragons. This time, Mishakal, the goddess of healing, answered his prayers. She neutralized the magical virus and wiped the dragons' memory clean of the event; as long as the stars shone in the heavens, the virus would remain inert.

Mishakal then punished Chief Talawillona for dealing with Chemosh in the first place, banishing him to the Garden of the Dead deep beneath Schallsea to suffer an eternity of damnation with other Wemitowuk miscreants. Chief Talawillona took the secrets of his dealings with Chemosh and Mishakal with him.

As the centuries passed, many changes came to Schallsea. The silver dragons abandoned the island, vowing never to return. Gradually, the Wemitowuk changed from savage warriors to peace-loving farmers who sought tranquility through rapport with nature. And Chief Talawillona became a respected legend; ironically, it was he who had started the tribe on the road from brutality to pacifism.

Though the virus of Chemosh was passed to each new generation of silver dragons, it remained dormant and harmless. But when Artha and Khardra caused the moons and stars to fade, the virus became active. Silver dragons began dying again as they had a thousand years before, but now they were dying throughout all of Krynn. Now, as then, the gods have chosen not to intervene. The cure remains buried with the tormented spirit of Chief Talawillona in the Garden of the Dead.

ROLE-PLAYING THE WEMITOWUK

The Wemitowuk are fearless, non-violent, and extremely courteous. A tribesman meeting a stranger always responds the same way: he stops whatever he's doing, clasps his hands in front of him, and silently stares at the ground. This is the Wemitowuk gesture of respect and deference. He remains in this position until the gesture is returned. If it is not returned, the Wemitowuk assumes he has insulted the stranger and, full of shame, refuses to speak until the stranger leaves. (When meeting the tribe's chief, a Wemitowuk not only clasps his hands and stares at the ground, but also drops to his knees.)

A Wemitowuk also shows respect by speaking as little as possible and choosing his words carefully. Excessive verbiage is considered a profound insult to the listener. Idle conversation is unknown in the Wemitowuk culture. Other points to remember:

— Wemitowuk stare at the ground while conversing; eye contact is considered offensive.

— Any questions or comments considered trivial are ignored so as to not be rude by wasting time with unnecessary words. For instance, the Wemitowuk would consider the following questions trivial: "How are you?", "What's your name?", and "What are you doing?". The DM decides if a question is trivial; if in doubt, the Wemitowuk is silent.

— Wemitowuk take long pauses responding to a question. (To simulate this, the DM may roll 1d4 for the number of minutes a tribesman waits before responding.) A Wemitowuk keeps his answers as direct and brief as possible. For instance, if asked if there are any dangerous animals on the island, a tribesman might think about his answer for two minutes, then say, "Yes." If asked how an angry god might punish the village, he might think it over for four minutes, then respond, "Destroy it."

STAIRWAY TO KRYNN

When dawn arrives on the day following the meeting with the Council of Cirulon, Terrilyn and Kerrija accompany the PCs to the entrance columns. Kerrija is cranky, saying he doesn't understand why it's necessary for him and his sister to go. Terrilyn, on the other hand, is excited. "Hurry up!" she says. "We're wasting time!"

The siblings begin a low roaring, which grows in volume until it is loud enough to make the cloudy foundations shake. The sky shimmers, and a sparkling crystal stairway appears once more, leading from the city downward through a bank of gray clouds. The stairway will lead them to the island of Schallsea on Krynn.

The steps are spongy and slightly warm. Each step advances the party a great distance, like the stairway that originally brought them to Cirulon. The stairway vanishes behind them as they walk. Terrilyn flies about, circling and darting ahead, while Kerrija brings up the rear.

Terrilyn peppers the PCs with questions about Krynn. "What are people like down there? Where do they live? What kind of clouds do you use for building?"

As the trip proceeds, Terrilyn's questions turn to Schallsea. "Have you ever been there before? What do you think we'll find there?" Terrilyn's studies of Krynn indicated there are no dragons on Schallsea (and a check of the Map Room (Location 13) would have confirmed it). Legend has it that the Schallsea people were at one time vicious killers of dragons. "Do you think that's true? You think they're still like that?" The more Terrilyn talks about Schallsea, the more nervous she becomes. By the time they near Krynn, Terrilyn is downright terrified, whimpering for protection from the blood-thirsty dragon-killers awaiting them below.

Kerrija remains silent during the trip. Twice during the four hour descent, he insists they stop to rest (lengthening their trip to five hours). "I haven't slept enough lately," he mutters, tucking his tail beneath him as he settles in for a brief nap. If the PCs disturb him while he naps, Kerrija growls and tells them to leave him alone.

SCHALLSEA ENCOUNTER KEY

(MAP 3)

ARRIVAL IN SCHALLSEA

The crystal stairway ends in a grassy glade in central Schallsea. The glade is surrounded by a green forest of tall pine trees (Area 1 on Map 3). The stairway vanishes when the last of the party steps off.

Warm sunshine and a soft breeze welcomes the party. The air is fresh and sweet, filled with the chirps of songbirds and the chatter of curious squirrels. Terrilyn forgets her fears and soars into the sky, playfully chasing a blue jay through the glade. Kerrija tucks his tail beneath him for a nap in the soft grass.

"I'll scout ahead and see if I can find anyone," says Terrilyn. "Back in five minutes." Before anyone can respond, she darts into the pine forest, heading straight north.

Terrilyn flies away too quickly for the PCs to follow. If they explore the immediate area, they find nothing but trees, grass and a few rabbits and chipmunks. Along the north edge of the glade are tangles of vines filled with fat purple grapes, juicy and delicious. (If the PCs work through the forest to the hills (Area 3), give them the information in "View From the Hills", below.)



When ten minutes have passed, Kerrija wakes up. "Where's Terrilyn?" he says, stretching and yawning. "Wasn't she supposed to be back by now?"

Twenty minutes later, there is still no sign of Terrilyn. Kerrija is worried. If no one else suggests it first, Kerrija says they'd better look for her.

If the party comes within a quarter mile of the cave (Area 2), they hear roars of pain from that direction. Kerrija recognizes his sister's voice and hurries the party along to investigate.

2. TERRILYN GETS THE POINT

When the party gets to within 50 yards of the hillside cave (Area 2), they clearly hear Terrilyn's cries coming from within. Two **giant porcupines** stand at the entrance, firing quills from their tails into the cave.

Terrilyn was returning from her scouting expedition when she spotted this cave. Curious, she investigated. The cave was empty, except for a nest of sticks containing three large, squirming porcupine babies. The parents, foraging in the brush nearby, rushed to the rescue. They blocked the cave's only opening and began tossing quills. The panicked Terrilyn uselessly exhausted her breath weapons trying to defend herself. Terrified, she has been howling for help.

If the PCs draw attention to themselves by making noise or attacking the porcupines, the porcupines turn from the cave and attack them, spraying them with quills from their tails. The porcupines fight to the death to protect their babies. Kerrija will not participate in the fight, staying out of sight behind a clump of thick shrubs; if the PCs ask for his assistance, he pants for breath weakly, saying he's too tired to help.

While the porcupines are busy with the PCs, Terrilyn can slip out of the cave: However, she's too frightened to leave without encouragement. If anyone shouts for her to get out or goes in to rescue her, Terrilyn slinks from the cave, her body riddled with six large, sharp quills.

Once Terrilyn has left the cave, the porcupines will no longer attack except to defend themselves.

If the PCs kill the porcupines, they can search the cave. There is nothing of interest aside from the giant babies.

Six quills pierce Terrilyn's hide (for a total of 11 points of damage). She whimpers for the PCs to remove them. While they attend to her wounds, she explains what happened, then asks the PCs to identify the monsters. "Do you think there are more of them around here?" she asks nervously.

After the PCs reassure Terrilyn about the porcupines, she tells them she thinks she spotted the village. "You can see it all from the top of the hills," she says. "Want me to show you?" Kerrija grumbles that they've had enough for one day, but "we might as well get it over with."

3. VIEW FROM THE HILLS

Terrilyn leads the party to the top of the low hills just north of the cave (Area 3). From this vantage point, they can see the following:

— To the west (Area 4), several barren oak trees rise from a meadow of short grass. There is activity of some sort among the trees.

— Directly ahead stretches a multi-colored corn field. A village of tents (Angat) lies beyond the field.

— To the east (Area 5), is a field on a hillside terrace. Three figures are working there.

The corn field provides enough cover so that the party could advance to the village without being seen by the tribesmen in Areas 4 or 5. If the party investigates this field, they find ears of all colors—yellow, red, blue, purple, brown,

green, and orange—grow here, as well as many colorful combinations, but they find no black or gray ears, not even a single kernel.

However, before the PCs go anywhere, they hear Kerrija gasp and cough. "Kerrija!" Terrilyn cries, rushing to him as he collapses. "What's wrong? What's happening to you?"

The coughing subsides, and Kerrija rolls over. At the base of his belly is a small purple blotch, a sure sign of the fatal dragon disease.

"Oh no," Whispers Terrilyn and huddles close to her brother.

Cure disease or similar spells have no effect on the disease. If the PCs ask, Kerrija tells them that he has been growing weaker for several weeks. He didn't notice the bruise until last night. "I can't go on with you," he says. "You must leave me here."

Terrilyn refuses to abandon her brother, insisting that the PCs continue without her. She asks them to find a safe place for the two of them to stay. (The grassy ravines on the southern flank of the hills are suitable.)

Under no conditions will Terrilyn go on with the party. If the party suggests they return to Cirulon, Terrilyn says that her brother is too weak. "There's nothing they can do for him up there anyway." One or more of the PCs could remain with the dragons, but there is little to do; Terrilyn attends to all of her brother's needs. (Terrilyn and Kerrija will be safe until the PCs return.)

It is now early afternoon. The sun will set in about four hours, and it will be dark within five hours.

4. SHAMAN'S TREE

If the PCs approach Area 4 before dusk, they see three men with dark brown skin wearing white breechcloths. Two are up a tree, tying gourds to its branches. (If it is after sunset, the men have left, leaving the gourds to hang mutely in the breeze.) The third man, watching from the ground, has a band of white feathers around his head. Three large birds are tied to nearby tree trunks.

The men in the trees are **Wemitowuk tribesmen**. The one on the ground is **Pawjada**, the shaman of Angat, the Wemitowuk village. The birds are **emre**, the tribesmen's mounts.

If the PCs don't interrupt, the men will tie gourds to the branches until dusk, then return to the village. If the PCs interrupt or otherwise make themselves known, the climbing men scramble down the trees and silently stare at the ground, their hands clasped in front of them.

Pawjada, deciding the PCs are demons and hence unworthy of respect, wiggles his fingers at them and shrieks one-word imprecations in an attempt to frighten them away. He ignores anything they say or do. Presuming the PCs aren't frightened away, Pawjada shrieks to his men who immediately untie and mount the emre. Pawjada also mounts an emre, and all three emre vault clumsily into the air. The emre circle once over the heads of the PCs, then retreat to Angat so Pawjada can warn the chief of the invading demons. Since Pawjada is always warning the chief about things that never happen, his report will be ignored.

If the party pretends to be scared of Pawjada and retreats, the men resume their gourd-hanging. If they return, Pawjada repeats his demon-scaring routine, retreating with his men if it fails.

If the tribesmen are attacked at any point, they retreat as described as soon as possible. They will not defend themselves. If a tribesman is captured, he refuses to speak.

The dried gourds have crude faces carved in them, an idea of Pawjada's to keep evil spirits away from the village. The gourds have no magical properties or monetary value.

5. TOMATO FIELD

If the PCs approach Area 5 before sunset, they see three thin men with dark brown skin and white breechcloths. They are digging weeds among neat rows of red tomatoes in the terraced field. (If it's after sunset, the men have returned to their village.)

The men are **Wemitowuk tribesmen** from the village of Angat.

If the PCs don't disturb them, the men work silently until dusk, then return to Angat. If the PCs interrupt or otherwise make themselves known, the men drop the pointed sticks they use for hoes and silently stare at the ground with their hands clasped in front of them.

The tribesmen won't identify themselves or describe what they're doing; wasting words on such trivialities is in extremely bad taste.

They refer most other questions to their chief. ("The chief might tell you.") If asked where the chief can be found, they simply point toward the village. They will take the PCs to the chief if asked.

ANGAT

Description

Angat, the Wemitowuk village, lies in a pleasant clearing. The hills to the southeast and north are terraced for crops, including beans, tomatoes, potatoes, peppers, and tobacco. To the west is a gentle stream called Tilawa Brook, to the south is the corn field. Small gardens of squash, melons, grapes, and pumpkins dot the perimeter of the village.

The village is composed of several dozen cone-shaped tents. The tents are built on pole frames and covered with brush, mud, and animal and bird skins. Since the Wemitowuk abhor needless killing, they regularly scour the woods for dead birds and animals for skins.

The Wemitowuk are thin, dark-skinned people with deep brown eyes and flowing black hair. The men wear only white breechcloths. The women wear white smocks and skirts. There are also emre, ostrich-like birds used as pack animals and mounts, foraging in the grass around the village.

Wemitowuk women generally stay close to home, making clothes from woven grasses and dried skins and roasting vegetables in pit ovens lined with hot stones. Many are skilled basketweavers who construct huge baskets for storing food, thick mats for sleeping, and *kani* dolls, small figurines shaped like humans and animals which bring luck and health.

Babies are tied to boards cushioned with mats of grass to keep them comfortable and safe. Older children run freely through the village, entertaining themselves by rolling hoops and throwing balls made of vines.

Usually, the Wemitowuk men can be found working in the fields or attending to the gardens, using pointed sticks to dig up the earth and sticks with a sharpened edge for cutting weeds. They sprinkle ashes on the crops for fertilizer.

The Wemitowuk fish for herring in Tilawa Brook using long rakes made from tree branches. The fishermen first throw a powder of chopped redweed root into the water which paralyzes the fish, making them easier to catch. (The fishermen will give the PCs a hollow gourd full of this redweed root powder if they ask. A victim who inhales the powder is paralyzed for 1d4 rounds if he fails a saving throw vs. breath weapons.)

Reaction to the PCs

Whether the PCs are led into the village by tribesmen or come here on their own, the tribal reaction is the same. As

soon as they see the PCs, the tribesmen drop what they're doing, clasp their hands in front of them, and stare silently at the ground.

The PCs may attempt to converse with the tribesmen, but they won't respond until the PCs also clasp their hands in front of them and stare at the ground. As always, the tribesmen won't identify themselves or describe what they're doing; wasting words on such trivialities is in extremely bad taste. The tribesmen refer most other questions to their chief, after an appropriate period of consideration (1d4 minutes). ("The chief might tell you.") If asked where the chief can be found, the tribesmen simply point toward the north end of the village.

As the PCs make their way through the village, they may notice Pawjada, the tribe's shaman, peeking at them from behind tents and wiggling his fingers at them in effort to scare them away. If pursued, he runs and hides. The other tribesmen, used to Pawjada's antics, ignore him. (Pawjada is described in "Shaman's Tree", above.)

The Spirit Pole

At the north end of the village is a tall, thick pole, originally a huge oak log. Engraved in the pole are oversized carvings of human faces. The left half of each face is painted red, the right half black. One face points west, one east, one south, and one north. This is a Wemitowuk spirit pole. The spirit pole watches over the village and sends the tribe's prayers to the gods.

The PCs can find the tribe's chief standing by the pole, contemplating it. If a tribesman is leading them, he takes them directly to the chief. Chief Owlalago has long gray hair and a deeply-wrinkled face. He wears a breechcloth made of silver dragon hide with purple stains, and a sash of white feathers draped over one shoulder and crossing his chest. As other tribesmen pass by the older man, on their way to or from the village, they clasp their hands and drop to their knees. The older man briefly clasps his hands each time, then waves them away to resume his study of the pole.

If the PCs approach, Chief Owlalago eyes them curiously, then waits for the proper greeting. He is very patient; he waits as long as necessary for them to clasp their hands and drop to their knees. (If they don't get the idea, have another tribesman pass by and demonstrate.) When they make the appropriate gestures, the chief clasps his own hands, then stands before them, staring at the ground, waiting for them to tell him what they want. (If no one addresses him appropriately, he continues to wait, indefinitely.) If the PCs stare at the ground and ask him any question or tell him they'd like to talk, the chief nods and motions for them to follow. Without waiting for a response from the PCs, he turns and walks to his tent, just a few yards away from the pole.

Discussion with the Chief

Chief Owlalago enters his tent without checking to see if the PCs are following. If the PCs enter the tent, they see the chief seated on the dirt floor with several hollow gourds in front of him. The chief doesn't look at them or in any way acknowledge their presence. They may stand or sit on the floor, whichever they prefer.

The chief pours water from a gourd jug into a large bowl, also made from a hollow gourd. He opens a basket and removes a handful of crushed spruce bark and several small emre bones. He places the bones and the bark in the water, then stirs it slowly with his finger. He lifts the bowl and takes a deep drink, then places the bowl before the nearest PC.

The mixture is a Wemitowuk friendship offering. Chief Owlalago will not speak until they all drink from the bowl; otherwise, he presumes that their rejection of his offering means he has somehow insulted them, and he will not risk





further offense by subjecting them to his words.

The mixture tastes like muddy water mixed with sour milk. It has no harmful or beneficial effects.

After all of the PCs have taken a drink, they can speak with Chief Owlago. He asks them no questions and will not initiate conversation; whatever information his guests wish to share is up to them.

Following are a list of subjects the PCs might want to discuss with the chief. Each subject is followed by the chief's initial answer. The chief always pauses before answering, and he may pause again between portions of his answer. Each pause lasts 1d4 minutes.

The information in parentheses following the chief's initial answer is what he actually knows about the subject. You can use this information to expand on the chief's answers if he is pressed about a particular subject. For example, if they show him the mouldy ears of corn that Abriele gave them, the chief pauses for 1d4 minutes, then says, "Rotten." If the PCs ask him if he's ever seen anything like them before, he might respond, "Yes." (Pause for 1d4 minutes.) "In hills to the east."

If you're unsure how to answer a question, the chief is silent.

The chief has nothing to hide and is very honest. He is just very slow.

If the PCs describe or display the mouldy corn Abriele gave them. "Rotten." (These ears of corn are no good for eating or any other purpose. They resemble vegetables that grow in the hills to the east of the village.)

Where are these vegetables? The chief points to the east. (If asked, the chief will have a guide show them this area in the morning.)

If asked about his dragon hide breechcloth. "Chief's clothes." Pause. "Dragon hide." Pause. "Hundreds of years old." (The breechcloth signifies the chief's leadership, as does his feather sash. The breechcloth is passed from generation to generation and is hundreds of years old; each new chief makes his own sash. He doesn't know anything about the spots, but knows the hide is from a silver dragon.)

Are there any dragons here? What happened to them? "No dragons now." Pause. "Hundreds of years ago." Pause. "They were sick." Pause. "They got well." Pause. "They left." (The chief isn't exactly sure what happened to the silver dragons, as the facts have been lost in the mists of time. He does know that dragons once flourished here but became infected with a fatal disease. A Wemitowuk chief named Talawillona saved the dragons, and soon after, the dragons left, never to return.)

If the PCs ask about the silver disease or how it was cured. "I don't know." (He doesn't.)

If the PCs ask about Chief Talawillona. "Great man." Pause. "Body never found." (The modern Wemitowuk don't know their ancestors hated Chief Talawillona and know nothing of his banishment. It is known, however, that he was never buried in the Wemitowuk burial grounds. No one knows what happened to his body.)

Where are the burial grounds? The chief points to the north. (If asked, the chief will have a guide show them this area in the morning.)

Why were the men hanging gourds from the trees? The chief just laughs. (It would be insulting to waste words discussing Pawjada's stupid idea.)

Who was the man wiggling his fingers at the PCs? "Pawjada." Pause. "Foolish man." (Pawjada is the tribe's shaman and the chief's brother-in-law. Pawjada knows no magic. If he wasn't a relative, the chief wouldn't tolerate his ridiculous antics.)

The PCs can remain in the chief's tent as long as they like. It is up to them to decide when their conversation has ended.

What Next?

If the PCs want to spend the night in Angat, Chief Owlago has a tribesman show them to an empty tent and give them a huge basket of fruit and vegetables to eat. They are free to explore the village. The tribesmen are no more talkative than usual, referring most questions to the chief. However, any tribesman will take the PCs to the burial grounds or to the field of rotten vegetables, but only during the day. The PCs are also free to explore these areas without escorts.

6. BURIAL GROUNDS

The Wemitowuk burial grounds (Area 6) lie in an open meadow roughly 50 yards in diameter, filled with wild flowers and surrounded by hills. It is about a mile north of the village. The burial grounds are easy to find, even if the PCs are unaccompanied.

A circle of white stones surrounds the burial grounds. There are no marked graves. (A thousand years ago, Chief Talawillona broke the circle of stones to give Chemosh access. The circle was repaired shortly thereafter and has remained unbroken ever since.)

There is nothing here of interest to the party. If anyone disturbs the circle of stones or otherwise desecrates the burial grounds, as soon as he leaves the area he feels a sharp pain in his stomach. For the next 24 hours, all of his attack rolls and Ability Checks are made at a -1 penalty, a result of a curse for disturbing the burial grounds. If he replaces the stones or otherwise repairs any damage he did, the curse disappears.

THE EASTERN HILLS

Locating the field of rotting corn that is similar to Abriele's black corn is crucial to discovering the cure for the silver dragon's disease. If the PCs haven't yet caught on to the significance of the corn, see "Troubleshooting" at the end of this chapter.

Finding the Field

The Wemitowuk have found no use for the hills due east of Angat. The few crops that do manage to grow there are unsuitable for eating or for any other practical purpose.

If the PCs are accompanied by a tribesman and either show him the ears of corn Abriele gave them or describe them to him, the tribesman leads them directly to Area 7.

If the PCs came here alone, they will have to search the hills for the rotten corn. For every hour someone searches, he has a 5% cumulative chance of finding Area 7. (For instance, if someone searches for three hours, he has a 15% chance of finding the area. If five PCs search for four hours each, they have a 100% chance of finding the area, presuming they are spread out and searching different sections of the hills.)

While they search, they may stumble across patches of tomatoes covered with black splotches, cabbages with black leaves, vines with pebble-sized gray grapes, and wild peppers with split skins that smell like rotten fish. Anyone foolish enough to sample them must succeed in a Constitution Check or suffer 1 hp of damage.

ROTTEN CORN

Rotting ears of black corn in gray husks grow in abundance on this hillside. The ears are identical to those given by Abriele in the Prologue.

If the PCs were led here, the tribesman will not step near the corn. At the first opportunity, he returns to Angat. Noth-

ing the PCs say can convince him to stay.

The soil here is soft and loose and gives off a faint odor of decaying vegetation. If anyone steps into the field, he sinks about a foot into the soil.

The entire field is supported by a tangled layer of roots three feet below the surface. The area below the layer of roots is a 20-foot-wide pit, 40 feet deep.

The PCs have no trouble digging into the soil. As soon as they reach a depth of three feet and expose any portion of the root layer to the sunlight (or starlight, as the case may be), the entire field collapses into the pit below. Anyone standing in the field must make a Dexterity Check. Those who succeed manage to grab a root, slowing their fall to the bottom of the pit. Those who fail plunge 40 feet to the soft earth below and suffer 2d4 hp of damage.

PCs still on the surface after the pit collapses can climb to the bottom by using the vines on the sides of the pit for handholds. Conversely, PCs inside the pit can climb the sides, reach through the tangle of roots to scrape away soil, and leave the pit when they've dug away enough soil to expose the roots to light.

Ten minutes after the field collapses, the roots begin to weave themselves together. Soil re-appears atop the layer of roots. Five minutes later, the patch is resealed, exactly as it was before the PCs arrived, once more hiding the pit from sight.

Anyone still on the surface after the field has resealed can dig another hole. As soon as a depth of three feet is reached and the roots are exposed, the field collapses again, exactly as before. Anyone who has taken precautions, such as holding the hand of someone standing outside the field, will not fall in.

At the bottom of the pit is an opening to the east. The opening is circular, about 10 feet in diameter, and leads to a passage that slopes downward.

GARDEN OF THE DEAD

(MAP 4)

UNDERGROUND PASSAGE

The underground passage winds deep into the earth and leads to the Garden of the Dead. The passage is circular, 10 feet in diameter. The sides of the passage are of packed soil, damp and cool to the touch. The air in the passage is thin and musty.

Crevasses and sinkholes can pose a threat to careless PCs. Anyone at the edge of a crevasse or sinkhole has a 5% chance of falling in. Sinkholes are about 20 feet deep; a falling PC lands in the soft earth at the bottom and suffers 1d6 hp of damage. Crevasses are hundreds of feet deep; a falling PC will never be seen again.

RANDOM PHENOMENA

As the PCs make their way through the underground passage, they experience a variety of supernatural phenomena generated by the forces in the Garden of the Dead (Location 10 on Map 4). Whenever the party enters an area marked with an X on the map, roll 1d10 and have them experience the indicated phenomenon. If a phenomenon is rolled again, refer to the *Subsequent Occurrences* information. All effects are cumulative; that is, someone under the effect of one phenomenon may suffer the effects of another at the same time.

You are free to alter the frequency or to choose specific phenomena as you see fit.

Roll	Phenomenon
1	a. Flashing Lights
2	b. Corn Alcohol
3	c. Clacking
4	d. Painful Legs
5	e. Strange Scents
6	f. Skin Crawl
7	g. Drum Beat
8-10	h. No Phenomenon

a. Flashing Lights. A 20-foot area fills with randomly flashing beams of lights. This effect persists for the next 2d6 rounds. There is no apparent source for the lights.

Subsequent Occurrences. A 20-foot area of the passage flashes as before, this time accompanied by shrieks of agony from unseen sources. The effects are harmless, but if the PCs happen to be in combat, all PC attack rolls are made with a -1 penalty due to distraction from the lights and shrieks. The effects persist for 2d6 rounds.

b. Corn Alcohol. The PCs taste corn alcohol in their mouths for 1d4 rounds. Even if a PC rinses his mouth, the taste persists.

Subsequent Occurrences. The PCs experience the same taste for 1d4 rounds. Each PC must make a Constitution Check. Those failing feel dizzy and sick to their stomachs as if intoxicated. For the next 2d6 rounds, these PCs make all attack rolls and Ability Checks with a -1 penalty.

c. Clacking. The PCs hear a soft clacking, similar to the sound of chattering teeth. The clacking echoes from a distance and has no apparent source. It lasts for 1d4 rounds.

Subsequent Occurrences. The PCs hear the same clacking sounds for 1d4 rounds. When the sounds stop, the air in front of the PCs shimmers, and the image of a huge, hovering skull appears, nearly filling the passage. The skull is transparent, with the exception of its two bulging eyeballs. The skull clacks its teeth at the PCs.

The image of the skull cannot be damaged, nor can it harm anyone. If touched by flesh, it vanishes and the clacking stops. Touching the skull with an object, such as a sword, does not affect it.

d. Painful Legs. The echoing whisper of a young man repeats in agony, "Leave my legs alone . . . leave my legs alone . . ." The whispering has no apparent source and lasts for 1d4 rounds.

Subsequent Occurrences. The PCs hear the same voice, again lasting for 1d4 rounds. Each PC must save vs. spells. Those failing feel sharp pain in their legs and immediately collapse to the ground. The pain persists for 2d6 rounds. An affected PC takes no damage but his legs are useless to him during this time; to move, he must either crawl or be carried.

e. Strange Scents. Strong aromas fill the air. The aromas have no apparent source and persist for 1d4 rounds. For each PC, roll 1d6 and consult the following chart. Each PC may experience a different aroma.

Roll	Aroma
1	Walnuts
2	Mint
3	Oats
4	Sassafras
5-6	No Aroma

Subsequent Occurrences. Roll for aromas as above. Each persists for 1d4 minutes. Each PC who experiences an aroma must succeed in a Constitution Check or suffer the following effects:

Walnuts. The PC doubles over with severe stomach cramps. The pain is so intense that he is unable to speak, walk, or do anything else for 1d6 rounds.

Mint. The PC experiences a pounding headache. The pain



is so intense that for the next 1d6 rounds, all attack rolls and Ability Checks are made with a -2 penalty.

Oats. Small red splotches break out all over the PC's skin. The PC feels feverish for the next 1d6 rounds (all Ability Checks at -1) and loses 1d4 hp of damage.

Sassafras. The PC faints. He recovers if someone shakes him, slaps him, or otherwise wakes him up. He suffers no damage.

f. Skin Crawl. The PCs feel a tickling all over their skin, as if tiny creatures were crawling on them. No such creatures can be seen, and there is no apparent source for the tickling. The tickling persists for 1d4 rounds.

Subsequent Occurrences. The PCs feel the same tickling sensation for 2d6 rounds. This time, however, they see the source of the tickling: ghostly ants cover their bodies. The transparent ants do no damage and have no effect on the PCs aside from the tickling sensation. If the PCs look closely at the ants, they see the ants have human heads. The heads' brown skin and black hair resembles that of the Wemitowuk. The PCs cannot communicate with the ants or brush them off; objects pass harmlessly through the ants' bodies.

g. Drum Beat. The PCs hear the slow, rhythmic beat of a drum, echoing and distant. The drum beats have no apparent source. The sound lasts for 1d4 rounds. (The rhythm pattern is given in Figure 1, at the bottom of Map 4.)

Subsequent Occurrences. The PCs hear the same drum rhythm, but this time it grows increasingly louder. The sounds last for 1d4 rounds. After the first round of the drum beat, anyone who doesn't cover his ears must save vs. spells or become totally deaf for 2d6 rounds after the drum beats end.

I. TUNNEL ENTRANCE

On the east side of the pit is an opening 10 feet in diameter. Cool, musty air drifts from the opening.

The opening leads to an underground passage that gently slopes downward into the earth. Once the roots reseal, the pit becomes pitch black. The passage is equally dark. The PCs must use torches or other light sources to see; there isn't enough heat here for the use of infravision.

2. SMALL MUD HOLE

A mud hole fills the next 15 feet of the passage floor. Two small objects float near the center of the mud.

Recent rains seeped through the ground and created mud puddles at various points in the passage. This mud is only about a foot deep. Wading through the mud reduces the PCs' movement to half rates.

The floating objects are broken **kani dolls**; the legs have been torn from the rabbit-shaped doll and only the head and one arm remain of the human-shaped doll. Both are ruined dolls created by the evil Hurricopah (Location 10f).

The **kani dolls** are stuck in the mud, unable to move. They attack if the PCs pick them up or move next to them.

3. GULLY OF THE DOLLS

Five dolls in the shapes of humans and animals crawl along the dirt in the watery gully ahead. The dolls appear to be made of hide and straw. All have missing limbs.

These are five more ruined **kani dolls**, crawling east to join Hurricopah (10f).

The dolls continually crawl between the mud holes of Locations 2 and 4; one hole blocks their path to Hurricopah, the other blocks their exit. The dolls attack anyone on sight and pursue as far as either mud hole.

A PC can attempt to avoid the crawling dolls by running past them. To avoid the dolls, he must make a Dexterity Check. If he fails by one, one doll has successfully attached itself to him. If he misses by two, two dolls attach. If he misses by three or more, three dolls attach (but remember that there are only five dolls).

4. LARGE MUD HOLE

The passage opens into a small cavern about 30 feet in diameter with a 30-foot ceiling. A mud hole spreads across the entire floor of the cavern. There are three openings on the opposite side of the mud hole where the passage continues.

This is another mud hole created by the recent rains. Wading through the mud reduces a PC's movement to half rates. In most places, the mud is only about a foot deep. However, there are also areas of deep, loose mud, capable of sucking an unwary victim beneath the surface.

If someone specifically states he is feeling his way as he crosses, there is no chance of his sinking in the mud. If he is not moving carefully, for each 10 feet he travels, he has a 20% chance of stepping in a pocket of deep, loose mud and beginning to sink at the rate of 1 foot per round.

There is nothing nearby that a sinking PC can use to pull himself free. Any single character can pull the sinking person free if he makes a Strength Check. Any two characters working together can easily pull him out.

If someone sinks below the surface, he can still be rescued as long as the others can feel around and find him. However, he continues to sink at the rate of 1 foot per round. If he isn't rescued before he sinks out of reach, he will never be seen again.

After the party has been in this cavern for three rounds, they attract the attention of four **stirges** nesting on the ceiling of the cavern. The stirges attack until two of them have been killed, after which the others retreat to the ceiling.

5. LOOSE RUBBLE

A crack in the side of the passage wall is filled with loose rubble.

The wall is weak in this section of the passage. If anyone attempts to dig away the rubble, pebbles spill from the crack. One round of digging later, the entire wall begins to collapse. The collapsing wall is easy to avoid; the PCs merely have to step back. After another two rounds, the wall stops collapsing, and both nearby branches of the passage are blocked with rubble.

It takes one person 40 minutes to clear away enough rubble so a human-sized character can squeeze through (it takes five 8 minutes, and so on). Otherwise, the party must backtrack and find another route.

6. DIRT MOUND

Mounds of dirt surround a 6-foot-diameter hole in an alcove in the north wall of the passage.

The hole leads to the lair of two **boring beetles**, a 20-foot-deep pit.

Fortunately, the beetles are resting in their lair and won't attack unless disturbed. If anyone starts down the hole, loose rocks and soil fall in and wake the beetles. Anything tossed in the hole also wakes them. Three rounds after they wake, they clamber up the hole and attack the PCs, attempting to kill as many as possible to eat later. If one of the beetles is killed, the other retreats down the hole. If the beetles are cornered in their lair, they fight to the death.

The pit is filled with mold and debris. If the PCs search the lair, they discover five pink pearls (600 stl each) and a *ring of swimming*, the inedible possessions of long-ago beetle victims.

7. RUSTLING CAVE

Low rustling noises can be heard from inside this small cave.

60 **bats** roost on the ceiling of this cave. When the PCs come within 10 feet of the cave entrance, the bats begin flying about the cave.

If either of the boring beetles (Location 6) are still alive, there is a 30% chance they will be attracted by the sounds of the disturbed bats and arrive seven rounds later. The beetles will pursue the PCs, but if a beetle has lost half or more of its hit points, it hides in its lair.

If anyone enters this cave, the frightened bats begin flying wildly about. Each PC in the cave has a 1 in 6 chance of being bitten each round.

The bats will flee from the cave after 5 rounds, heading out of the tunnel. There is nothing of interest in the cave.

8. EERIE GUIDE

The passage opens to a vast cavern with an 80-foot high sloped ceiling, sheer granite walls, and a smooth, featureless floor of packed earth. Glowing mold from the ceiling bathes the cavern in a soft, greenish light. There are no other passages leading from the cavern.

In the center of the cavern is a cone-shaped tent enveloped in wisps of white mist. Built on a pole frame and covered with brush, mud, and hides, the tent is similar to those in Angat.

(There is nothing in the cavern to distinguish areas 8a, b, and c from each other; the dotted lines are solely for the DM's reference.)

As soon as anyone sets foot in area 8a, the entire cavern fills with randomly flashing beams of light. When someone enters area 8b, shrieks of agony from unseen sources accompany the light flashes. If everyone leaves the cavern or steps inside area 8c, the effects stop instantly.

The tent flap is closed. If someone lifts it to peer inside, he sees nothing but a smooth floor of packed earth.

However, as soon as someone enters the tent, the packed earth begins to crack. A moment later, the blade of a shovel pokes through the floor, followed by a bony arm. A **skeleton**

pulls himself halfway out of the floor and stares at the PCs. In one hand, he holds a spade. With the other, he beckons for them to follow him.

The skeleton carries a special *spade of colossal excavation* which allows him to dig 1 cubic yard of earth per round. The earth dug with this spade disappears for 24 hours, then reappears exactly where it was before it was dug away.

The skeleton presumes the PCs are new arrivals condemned to the Garden of the Dead, and it is here to guide them. It will not defend itself if attacked. If destroyed, its parts magically reassemble in ten minutes. The skeleton then crawls back in the hole and resumes beckoning the PCs to follow it.

If the PCs destroy the skeleton, they could take the *spade of colossal excavation* before the skeleton reassembles, but since it is unlikely they know the route to the Garden of the Dead, it won't do them much good. Meanwhile, the reassembled skeleton will crawl back in the hole and wait for the PCs to return the *spade* to it.

If anyone approaches the skeleton, it begins to dig a tunnel. Again, it motions for them to follow. The skeleton's tunnel angles downward and is only about 4 feet in diameter. If they follow, they will have to crawl.

The skeleton continues to dig, following the winding route indicated on Map 4. All attempts at communication with it are futile. If the party attacks the skeleton while they follow it through its tunnel, it will not defend itself. If destroyed, it magically reassembles ten minutes later, then continues to dig. If the PCs take the *spade*, it patiently waits for its return.

The trip through the skeleton's tunnel is otherwise uneventful, as the skeleton knows the best route.

9. VEIL OF MIST

The tunnel opens into a small, featureless cave. In the opposite wall is a circular opening about 10 feet in diameter. A veil of green mist obscures the opening.

The skeleton gestures for the party to walk through the misty opening. If they hesitate, the skeleton goes through first. They feel a chill ripple through their bodies as they pass through the mist, but the mist has no harmful effects.

10. THE GARDEN OF THE DEAD

The passage opens into a huge cavern over 100 feet in diameter with sheer granite walls and a ceiling 100 feet high. Glowing mold from the ceiling bathes the cavern in a soft, greenish light. There are no other passages leading from the cavern. The cavern smells of rotting vegetation and is as quiet as a graveyard.

A corn field fills the floor of the cavern. The corn stalks and ears are black. The stalks wave back and forth as if blown by a gentle breeze. However, there is no breeze here; the air in the cavern is perfectly still.

There are six cone-shaped tents spaced throughout the corn field. The tents are enveloped in wisps of white mist and appear to be made of black corn stalks.

(As in Location 8, the dotted line *h* is only for the DM's reference.)

Once everyone has passed through the mist, the corn stalks at 10a begin to crackle and move, gathering themselves into the shape of a cone. A minute later, the stalks have woven themselves into a tent, identical to the others in the cavern.





The skeleton motions for the party to follow it to the new tent. Still under the impression that they are fresh arrivals condemned to the Garden of the Dead, the skeleton is showing them to their new home. The skeleton doesn't care whether they enter their tent or not; its job is done. Once it has shown them their tent, it digs a shallow trench near the cavern entrance and lies in it, remaining inert until the next new arrivals reach its tent (Location 8).

About the Garden

The Garden of the Dead is reserved for Wemitowuk who have committed the most heinous crimes against the gods or their fellow tribesmen. Through the centuries, only a handful of Wemitowuk have committed crimes of sufficient magnitude to warrant condemnation to an eternity in the Garden of the Dead.

The criminals in the Garden of the Dead exist as various undead entities. Each resides in a separate tent. The flaps to all the tents are closed. An entity will not leave its tent unless someone disturbs it (as by opening the flap, making excessive noise, or attempting to destroy its tent). If disturbed, the entity leaves its tent to wreak havoc.

All entities will fight until destroyed. They do not attack one another—in fact, they ignore each other. However, they recognize that the PCs are not like them, and this realization enrages them.

They will not leave the Garden of the Dead, nor will they enter any other tent. Thus, the PCs are safe beyond the green mist or inside their own tent. If an entity pursues someone to a safe tent or the mist, the entity waits for at least 2d10 rounds. After that time, there is a 50% chance it continues to wait until another PC appears; otherwise, it shambles back to its own tent. Each time a PC appears and then disappears, provoked entities wait for another 2d10 rounds and then each checks once more to see whether it returns to its own tent.

Except where indicated, it is impossible to communicate with the entities. None of the entities in the Garden of the Dead are affected by clerical turning.

It may occur to the PCs to leave the Garden of the Dead and return to Angat for help. Besides wasting valuable time, the effort will fail, as no Wemitowuk can be convinced to enter this foul place.

When the PCs discover Chief Talawillona (tent g), proceed to "Rescuing Talawillona".

10a. New Tent

This newly-created tent is supposedly where the PCs will spend eternity. The tent is made of woven black corn stalks. There is nothing inside.

10b. Tent of Sour Smells

This tent reeks with the scent of corn meal and alcohol.

It is Pavasusu's tent. When Pavasusu was a young woman, she stole an ear of blue corn from a stalk growing in the tribe's sacred burial grounds, intending to use the fat blue kernels to make a necklace. That night, she received a vision from the gods ordering her to plant one of the stolen seeds behind her tent. She was to raise the corn for a year, harvest the ears, and return one to the burial grounds. If she neglected to do this, the gods would punish the entire village.

Pavasusu did as she was told for a month. However, one day in a drunken rage from too much corn alcohol, she ripped the corn stalk from the ground and tore it to pieces. The gods responded with a plague on the tribe's entire harvest. Many of the tribe died of starvation that year, and Pavasusu was condemned to the Garden of the Dead as a **juju zombie**.

Pavasusu has filthy black hair and burning eyes. She wears a ragged hide apron. Corn kernels sprouting from her skin cover her entire body (accounting for her increased AC). Corn meal continually trickles from her open mouth.

Anyone within 10 feet that Pavasusu can see must save vs. spells. Those failing feel dizzy and sick to their stomachs as if they were intoxicated. For the next 2d6 rounds, these PCs make all attack rolls and Ability Checks with a -1 penalty.

Pavasusu attempts to strangle PCs, attacking human females first.

10c. Tent of Mumbles

Low muttering and mumbling can be heard from inside this tent. It is the tent of Qahitloq, a former Wemitowuk shaman with an obsessive fascination for bringing the dead back to life. An unholy ceremony inadvertently resurrected all of the dead animals within a mile of Angat. The undead animals went on a rampage of destruction and killed more than half of the villagers. Qahitloq was condemned to the Garden of the Dead as a **wight**.

Qahitloq wears a bear-skin costume and a **skull mask** with bulging eyeballs. He constantly mumbles half-remembered spells under his breath. He attempts to completely *drain life* from PCs; anyone totally drained of life energy becomes a wight under Qahitloq's control. A *raise dead* spell destroys him, and holy water causes 2d4 hp of damage.

If Qahitloq is destroyed, his **skull mask** flies from his head and attacks. It pursues the PCs, even into other tents and beyond the Garden of the Dead. It fights until destroyed.

10d. Tent of Moans

Low, guttural moans come from inside this tent. It is the tent of the cruel Tohopote, who was responsible for training Wemitowuk warriors back in the tribe's days of savagery. Tohopote forced a group of 40 young Wemitowuk men to carry logs and heavy stones from one end of Schallsea to the other, applying a torch to the legs of those who moved too slowly. He commanded them to enter a deep pit and stay there until he told them to leave. The pit turned out to be a lair of giant ants. All the men were killed, and Tohopote was condemned to the Garden of the Dead as a **zombie**.

Tiny ants swarm over Tohopote, covering his body from head to toe. He moans incessantly, even when attacking someone, and when not otherwise occupied, absently wipes ants from his body (which immediately scramble back up his legs as soon as they are brushed off). If killed, Tohopote's body crumbles to dust, revealing a squirming **giant ant**. The ant attacks the nearest PC and fights to the death.

10e. Tent of Sweet Scents

The sweet smells of walnut, mint, sassafras, and oats drift from this tent. It is the tent of Chupchus, a former medicine man who claimed his power was greater than that of the gods. Rather than allowing the tribe to appeal to Mishakal for a cure for an outbreak of smallpox, Chupchus arrogantly insisted they use his useless medicines instead. As a result, dozens died from smallpox, dozens more from his poisonous potions. Chupchus was condemned to the Garden of the Dead as a **juju zombie**.

Chupchus has filthy black hair and burning eyes. He wears a ragged white breechcloth. His body is covered with a tangle of vines and roots growing from his skin.

Anyone touched by Chupchus must save vs. spells or suffer one of the following effects:

1. He is overwhelmed by the aroma of walnuts and doubles over with severe stomach cramps. The pain is so intense that he is unable to speak, walk, or take any other actions for 2d6 rounds.

2. He is overwhelmed by the aroma of mint and experiences a pounding headache. The pain is so intense that for the next 2d6 rounds, all attack rolls and Ability Checks are made with a -2 penalty.

3. He is overwhelmed by the aroma of oats, and small red splotches break out all over the his skin. He feels feverish for the next 2d6 rounds and loses 2d6 hp of damage.

4. He is overwhelmed by the aroma of sassafras and faints. He recovers if someone shakes him, slaps him, or otherwise wakes him up.

10f. Tent of Soothing Words

A woman's soft voice can be heard from inside this tent, endlessly repeating, "My babies. . . my babies . . ." It is the tent of Hurricopah, who was once responsible for making good-luck *kani* dolls for the entire tribe. In love with the mate of her sister, Hurricopah made a deal with the gods of evil—she would make the *kani* dolls to their specifications and they would give her a potion to force her sister's mate to fall in love with her. The potion worked, but during the next high sanction of Nuitari, the *kani* dolls came to life and attacked the Wemitowuk in their sleep, killing dozens of them. Hurricopah was condemned to the Garden of the Dead as a **juju zombie**.

Hurricopah has filthy black hair and burning eyes. She wears a ragged white apron. Ten *kani* dolls cling to her body by their teeth. She continually strokes and soothes them, cooing, "My babies. . . ." (After Hurricopah was banished to the Garden of the Dead, the Wemitowuk tribesmen tore her *kani* dolls apart and buried them in a mass grave. Over the years, some of the dolls managed to free themselves from their grave and have crawled here for Hurricopah to repair them.)

If Hurricopah is killed, the ***kani* dolls** detach from her body and attack the PCs. They pursue the PCs, even into other tents and beyond the Garden of Death if necessary. The dolls fight to the death.

10g. Tent of Drumming

The slow, rhythmic beat of a drum comes from inside this tent. If the PCs experienced Random Phenomenon g, they recognize the rhythm (given in Figure 1).

This is the tent of **Chief Talawillona**. Unlike the other residents in the Garden of the Dead, the chief has not been transformed into an evil entity. Instead, he is in a state of *temporal stasis* and under a special *command* to play this drum pattern until the end of time.

The chief has not aged a day since he arrived in the Garden, a thousand years ago. He has handsome features, long black hair, and wears a white breechcloth. His white feather sash is still draped over his shoulder. He plays his drum, a section of hollow log with dried emre skin stretched over it, with his hands.

Chief Talawillona does not acknowledge the PCs if they enter his tent, and ignores anything they say. Though he will not attack them, he refuses to move. If the PCs want to take him back to Angat, they will have to carry him. He will continue to beat his drum unless it is taken from him, after which he continues to beat the air.

However, if a PC clasps his hands and drops to his knees, Talawillona recognizes the Wemitowuk chief's greeting, and the special command spell is no longer in effect. He stops beating his drum. A moment later, tears trickle from his eyes and he begins to mumble. If anyone comes close to the chief, he can hear "Take me home. . . take me home" If the PCs lead the chief by the hand, he will follow them. He will not engage in combat either in the Garden of the Dead or elsewhere in the caverns.

RESCUING TALAWILLONA

The PCs can lead or drag the chief out of the Garden through the tunnel dug by the skeleton. (The skeleton remains in the Garden of the Dead.) Roll as usual for Random Phenomena in the cavern passages, but some of the phenomena have been deactivated. The Drum Beat (g) is not active if Talawillona is no longer trying to beat his drum. Other phenomena are deactivated if the appropriate entities have been destroyed:

Destroyed Entity

Pavasusu (tent b)
Qahitloq (tent c)
Tohopote (tent d)
Chupchus (tent e)

Deactivated Phenomenon

b. Corn Alcohol
c. Clacking
d. Painful Legs and f. Skin Crawl
e. Strange Scents

Once back in the entrance pit, the PCs can climb the sides, reach through the tangle of roots to scrape away soil, and leave the pit when they've dug away enough soil to expose the roots to light. If no longer under the *command* spell, the chief can climb out; otherwise, they'll have to hoist him out.

Once out of the pit, the chief is no longer affected by the *command* and *temporal stasis* spells. He clutches his head and falls down. A moment later, he lifts his head and stares at the party in amazement. He sniffs the air. "It smells good here," he says, taking a deep breath.

The chief asks the names of his rescuers and how they got him out of the pit. He takes the hand of each one and thanks them for their help. "I am very tired," he says. "I must rest a while."

If the PCs asks the right questions while the chief rests, he tells them why he really was condemned to the Garden of the Dead (see "DM's Background" at the beginning of this chapter) and the stories of the other entities in the Garden. If they ask about a cure for the silver dragons, the chief says only, "That is up to the gods."

After an hour, the chief insists that he must return to Angat and asks the PCs to go with him. (If they refuse, see "Trouble-shooting" at the end of this chapter.) They have walked no more than a few yards when Pawjada springs out from behind a clump of bushes and frantically wiggles his fingers at them. Pawjada gets a good look at Chief Talawillona, shrieks, and races away over the hills. If the PCs catch Pawjada, he does nothing but shake in fear. The chief tells them to let him go.

TALAWILLONA TRANSFORMED

RETURN TO ANGAT

When Chief Talawillona strides into Angat, the tribesmen stop in their tracks, then fall to their knees and clasp their hands in front of them. (If it is nighttime, Pawjada's shrieks have awakened them.) Talawillona ignores them and goes directly to the spirit pole. If he no longer has his drum, he asks for another; any tribesman can locate one.

Once he has a drum, Talawillona tells the PCs, "Stay near." He then closes his eyes, goes into a trance, and begins to play his rhythmic pattern (Figure 1).

The chief will play the pattern until Solinari or Lunitari shows in the night sky, either waning, waxing, or at high sanction. (Note that this can't take more than two days regardless of the moons' current positions. If the chief begins playing at night when one of these moons is already visible, he must play at least an additional 24 hours.)





VOICE OF THE GODS

At midnight when either Solinari or Lunitari shines in the sky, a shaft of light beams from the moon and strikes the spirit pole. The pole begins to glow, and Chief Talawillona stops playing.

Talawillona rises and speaks to the spirit pole. "I ask for mercy."

All four of the faces on the pole speak as one. "Who stands with you?"

None of the tribesmen, who are watching with wide eyes, step forward. If none of the PCs volunteer to stand with Talawillona, he turns to them. "Please. To save the dragons." (If no PC volunteers, see "Troubleshooting".)

If one or more of the PCs volunteers, the spirit pole addresses them. "If he betrays us, you join him for eternity in the Garden of the Dead." Give them a moment to reconsider their decision.

A shaft of light then flashes from the spirit pole and envelops Chief Talawillona in a glowing sphere. The sphere expands, then bursts like a bubble. Chief Talawillona has been transformed into a floating, translucent spirit filled with sparkling mist.

THE CURE

The PCs hear Talawillona's voice in their heads, telling them that the gods have instructed him to cure the dragons suffering from the silver disease, after which his soul will be allowed a peaceful afterlife. "Lead me," he says.

If it occurs to them to lead him to the ailing Kerrija, continue with the following section.

If the PCs can't think of anywhere to send him, Talawillona's spirit bids them farewell and drifts into the heavens to seek out diseased silver dragons. The first one he finds is Kerrija, and the dragon has been cured by the time they get back to the siblings' ravine. In this case, Terrilyn can tell them how Kerrija was cured.

SAVING KERRIJA

Kerrija's disease has worsened considerably since arriving on Schallsea. The purple stains now cover most of his belly and are spreading to the rest of his body. Terrilyn has all but given up hope.

As soon as the party leads Talawillona's spirit to the siblings' hiding place, he studies Kerrija briefly, hovering in front of him. Talawillona places his sparkling, misty hands gently on Kerrija's face. "Open your eyes," he whispers. Painfully, the dragon does so.

"Look at me," says Talawillona. "Don't be afraid." Two shafts of soft silver light beam from his translucent eyes to Kerrija's eyes. The beams slowly change from silver to purple, and as they do, the purple stains begin to fade from Kerrija's body.

Kerrija thrashes, but Talawillona holds him firmly. "Be still," he says. The beams of light gradually transform from purple to silver and back again. Kerrija chokes and coughs, struggling weakly to free himself from Talawillona's grip. Talawillona soothes him. "It will be over soon," he says.

A few minutes later, Talawillona removes his hands from Kerrija's face, and the light fades from his eyes. Kerrija slumps to the ground.

Talawillona gently caresses Kerrija. "Have faith," he whispers to him, "and you will live."

"He rests now," says Talawillona, then turning to Terrilyn, "You will care for him?" Terrilyn nods, wide-eyed.

"I must go," says Talawillona, and begins to rise into the air. "I will find the others." He floats higher into the clouds, then streaks toward the horizon, a blur of brilliant light.

Tears stream from Terrilyn's eyes as she snuggles close to Kerrija. Kerrija grunts, then rests his head on his sister's hind leg. "What happened to me?" he moans.

Terrilyn lifts her head to the sky and roars. The sky shimmers, and a sparkling crystal stairway appears to take the dragons and the weary party back to Cirulon.

TROUBLESHOOTING

Here are some tips for handling unexpected problems:

If they can't find the Garden of the Dead. If the PCs don't pick up on Abrielle's mouldy corn clue from the Prologue, Pawjada might lead them to the hills of rotting vegetables; he's afraid of them and might want to get them lost in the eastern hills. If it doesn't occur to the PCs to dig up the corn field, it is conceivable that enough light has leaked through the surface to weaken it. Just standing in the field might cause it to collapse.

If they don't go to Angat with Talawillona or refuse to stand with him at the spirit pole. Chief Owalago stands with Talawillona instead. Talawillona still becomes the curing spirit and cures Kerrija before they return to Cirulon.

CHAPTER 4: ISLE OF DRAGONS

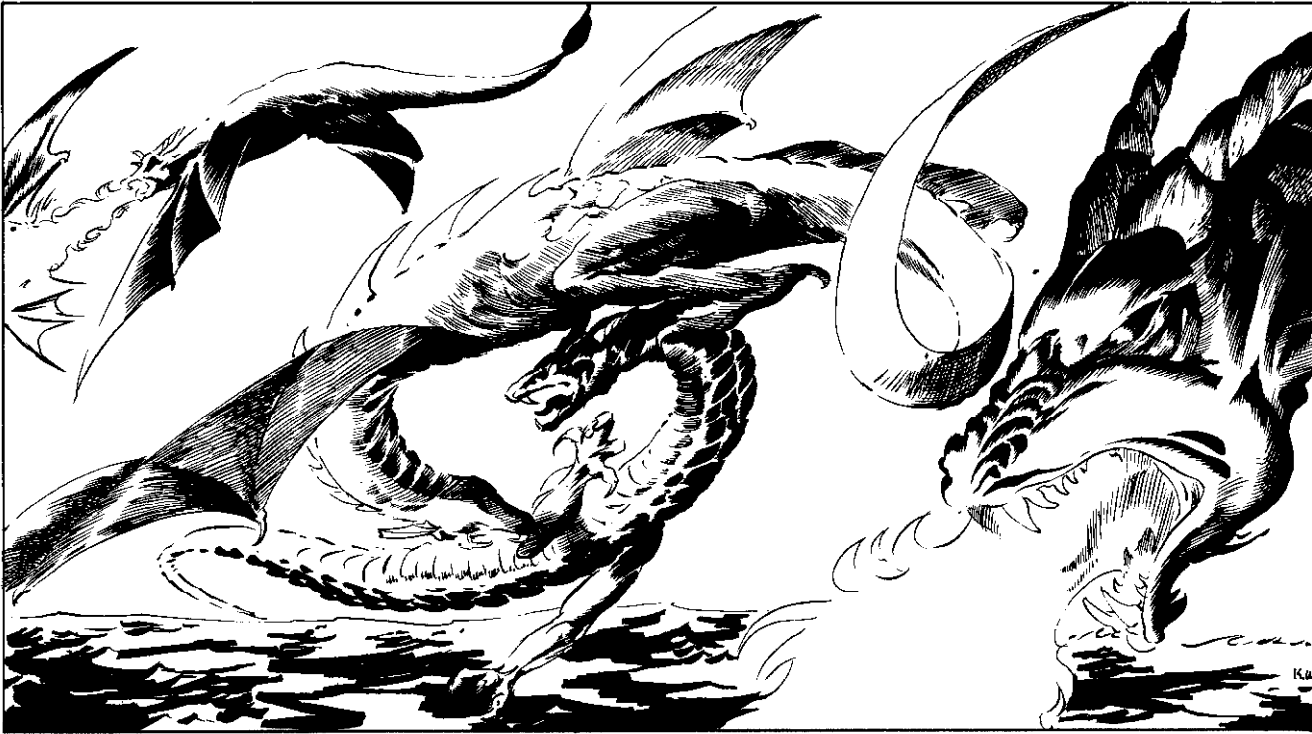

DM's OVERVIEW

This chapter begins immediately after the events in Chapter 3. Use the large color insert map of Cirulon and map 5 in the center pull-out section for reference.

In this chapter, the PCs should:

- learn the significance of the Astral Dragon and her relationship with Abriele,
- learn that Abriele has a baby,
- learn that Khardra's essence still exists, and
- confront a second dark tower as it attacks the Isle of Dragons.

DM's BACKGROUND

Having learned that the secret portal is not in Cirulon, Artha has turned her attention to the Isle of Dragons, a logical location for the portal considering the island's significance to good dragons. Like Cirulon, the Isle of Dragons has been used for centuries as a refuge and stronghold. In recent weeks, there has been much activity on the Isle of Dragons, which seems to confirm Artha's suspicions. (Artha is wrong again. The portal is not located in the Isle of Dragons. The good dragons have been moving some of their art objects and other treasures to the island for temporary storage. They are also hoping to lure an over-confident Artha to the island where the good dragons are certain they can beat her. As will be seen, the portal is actually located on the neutral moon of Lunitari.)

Shortly after the final attack on Cirulon, an army of evil dragons under the direction of Artha began assaulting the Isle of Dragons. The battle has not gone well for her. The good dragons, fighting at full strength since the moons and stars stopped fading, have so far successfully defended the isle and have inflicted heavy casualties on the evil dragons.

But Artha has a plan she thinks will turn the tide in her favor. She is sending the second Tower of Kajhun to assault the island. It is traveling underwater to maximize the element of surprise. More importantly, Artha has retrieved the spirit of her destroyed consort, Khardra, from the Shadowglades. She plans a "blending" ceremony that will not only make the tower invulnerable to the good dragons, but will also ensure the destruction of the island if the secret portal isn't revealed to her.

RETURN TO CIRULON

On the way back to Cirulon, Terrilyn wants to know all about the PCs' adventures with the Wemitowuks. Kerrija solemnly pledges his friendship to the PCs.

Once the party steps through the columns of Cirulon, the last of the crystal stairway vanishes. "We're supposed to take you to the Council as soon as you're ready," says Terrilyn. If the party would like to rest first, the siblings lead them to the Silver Philosophy Gallery (Location 17), a safe place to spend a few uninterrupted hours. If the PCs are ready to face the Council, Terrilyn leads them to the Council Chamber (Location 21) while Kerrija rests.

REPORT TO THE COUNCIL

The doorway to the Council Chamber opens automatically when the PCs approach. As before, Terrilyn is not allowed inside. "Remember to tell the truth," she whispers.

Alcuin, Anaximander, Strato, Spir, and Tertullian each lounge in their metallic nests. Abriele sits comfortably in the crystal nest.

The door closes behind the PCs. "Come forward," directs Alcuin politely (in a deep, grating voice). "Stand before us."

Once the PCs move to the center of the room, Alcuin continues. "We know of your success on Krynn. Thanks to your efforts, the bond between us is stronger this day."

"Congratulations," adds Anaximander (breathy and barely audible).

"I am extremely surprised," says Strato (high-pitched creak).

Tertullian is grateful. "You have saved countless lives, including that of my grandson." (Human-like voice.) "Approach me. Extend your hands." Tertullian presses each PC's hand in turn, leaving a tiny silver scale imbedded in each palm.

"You are now citizens of Cirulon. This scale is recognized by all silver dragons. They will materialize the crystal bridge at your request."

There is a moment of silence, then Alcuin speaks.

"If you would do us the honor, we would like to hear details of your experiences with the Wemitowuk."

The dragons want to know what the Wemitowuk are like, particularly if they still prey on dragons as they did a thousand years ago. They want to know the origin of the disease and what the party did to bring about the cure.

If they don't bring it up themselves, Alcuin asks how they found Chief Talawillona, specifically how they found the entrance to the Garden of the Dead. (Phrase Alcuin's questions so the PCs are encouraged to mention the mouldy ears of corn that Abriele gave them in the Prologue. For instance, Alcuin might ask, "How did you know what to look for? What was special about that particular range of hills? How did you know to look for corn and not, say, tomatoes?")

When the PCs mention the ears of corn, Alcuin asks where they got them; if they've already mentioned that Abriele gave them the corn, Alcuin asks them to repeat themselves. "I don't think I heard you."

When it's clear that they are talking about Abriele, Spir snorts. "Impossible. That can't be." (A smooth tenor voice.)

"That would mean," says Alcuin, turning to Abriele, "that you knew how to cure the silvers all along."

Abriele says nothing.

"Speak!" demands Alcuin.

Abriele speaks softly, her voice without emotion. "I gave them the corn."

"And my dream of the Wemitowuks," says Tertullian. "Did that come from you as well?"

"Yes," says Abriele.

"Have you known all along how to save the silver dragons?" asks Alcuin.

"Yes."

"Then you allowed my friends to die," whispers Tertullian, her voice trembling. "My grandson . . ."

Tertullian roars in despair. Strato and Spir angrily accuse Abriele of murder. Anaximander looks shocked. Alcuin says nothing.

If the PCs try to give an opinion, ask a question, or leave, their words are ignored. If they persist, Strato angrily snaps at them, "Be still! This is more important than anything you have to say!"

When the dragons calm down, Abriele speaks. "My role is

to maintain the sacred balance among good, evil, and neutrality. On reflection, perhaps I should have done nothing at all. But I remembered the alliance between good and neutral that kept evil from triumphing a long time ago and acted on that. Whether I did too much or too little. . . I am not certain. But that is not why I am here now.

"The balance has swung too far toward evil. I am here to help."

"We've had enough of your help," Strato sneers.

Abriele ignores him. "The Isle of Dragons is threatened by Artha and the evil dragons. There is a second tower—"

Strato cuts her off. "That's enough. We have no interest in anything else you have to say."

Abriele stiffens, her fur standing out. "Very well." She *plane shifts* and instantly disappears.

Alcuin breaks the uneasy silence following Abriele's abrupt departure. "Our apologies," he tells the party. "Our problems with Abriele have nothing to do with you."

"Alcuin is correct," adds Tertullian. "We will deal with Abriele another time."

"Have you any questions for the Council before you go?" asks Anaximander. "As citizens of Cirulon, you have the right."

If the PCs ask the right questions, they receive the following responses. Alcuin once more speaks for the dragons.

Who or what is Abriele? Why was she here? "Abriele is an emissary of the Astral Dragon, the personification of neutrality who resides on another plane of existence. The Astral Dragon sent Abriele to Cirulon to observe and advise." (Fearing that he might compromise the relationship between the good dragons and the Astral Dragon, Alcuin has nothing more to say about Abriele, the Astral Dragon, or any related subjects. If pressed for information, Alcuin says, "I am sorry. We can say no more.")

What about the threat to the Isle of Dragons Abriele mentioned? Is there a second tower? "For several days, an army of evil dragons directed by Artha has been assaulting the Isle of Dragons. Their forces are no match for ours and we expect victory soon. We have learned from sources on Krynn that Artha is sending a second dark tower to the Isle of Dragons. It poses no threat."

What makes you think you can beat Artha so easily this time? "When Artha attacked Cirulon, we fought at a disadvantage because of the weakness caused by the fading stars and moons. The fading has stopped, and we now fight at full strength."

Can we help? "It is not necessary. You have done enough. And unfortunately, most of the dragons on the isle still have reservations about your kind. You would not be welcome."

Why is Artha attacking the Isle of Dragons? "Like Cirulon, the Isle of Dragons has been used for centuries as a refuge and stronghold for good dragons. It is also where we have temporarily stored some of Cirulon's art treasures." (The PCs may feel this is a less than satisfactory answer, but Alcuin won't mention or confirm that Artha apparently believes the portal is on the island.)

What is the portal Artha is looking for? "We have nothing to say about that." (Alcuin will not elaborate.)

When the questions end, Alcuin thanks them once more on behalf of the Council and adds that they look forward to another visit after Cirulon is rebuilt. They are invited to spend the night in Cirulon.

The doorway opens and Alcuin excuses them. The doorway closes behind them.

ABRIELE, AGAIN

ABRIELE'S PLEA

Once the PCs leave the Council Chamber, they're on their own. Terrilyn is nowhere in sight; apparently she retired to the Silver Philosophy Gallery to care for her brother.

Other dragons are bustling about (as only dragons can), attending to debris and the beginning of a long rebuilding process. However, before the party can choose a destination, Abriele abruptly appears before them. "Please," she begs earnestly. "You must hear me out. The dragons are still in great danger. Will you allow me to show you?"

If asked for more information, Abriele insists they must come with her; they must see for themselves. If they refuse, she tells them that it may be a matter of life or death, "and the balance has swung too far toward evil. I am in part responsible. I must restore the balance." (If the PCs still decline, see "Troubleshooting" at the end of the chapter.)

If the PCs agree to go with her, Abriele asks them to group together, then blasts them with her breath weapon, *shrinking* them to 5% of their normal size. (Magic resistance has no effect against it.) She gestures for the PCs to climb on and hold on to her fur. When they are firmly seated, she *plane shifts*.

ABRIELE'S HOME

A moment later, the PCs find themselves on a plateau of smooth, white stone. It is perfectly circular, about 20 feet in diameter. The stone has a chalky texture and smells vaguely of graphite. Its only feature is a five-foot-wide hole in the middle of the plateau.

The plateau is the top of a column made of the same white stone. The column is smooth and sheer, nearly a half-mile tall. It rises from an ocean of still, clear water which extends in all directions as far as the eye can see. There are no other columns standing in the ocean; in fact, there are no features of any kind, either in the ocean or on the horizon.

The air is still and cool. There are no sounds of any kind. The sky is a brilliant red with a few dark brown clouds. There are no stars or suns. It is impossible to tell the time of day.

Abriele uses her *cancel shrinking* breath weapon to enlarge the PCs to their normal sizes. "This is my home," she says, gesturing around the plateau.

She walks to the edge of the plateau and asks the PCs to join her. "Come. See how the battle goes."

Abriele closes her eyes, going into a trance. A few minutes later, the ocean below ripples and glows. The image of an island fades into appearance in the ocean. The image is so perfect, it is as if they were looking down at an actual island, from about half a mile above it.

This is the Isle of Dragons, an island of towering stone mountains and scattered forests. Dozens of good dragons—gold, copper, bronze, and brass—soar above the island; many more are scattered on the beaches and perched on mountain peaks. A lesser number of evil dragons—red, blue, black, and green—hover off the island, soaring in wide circles, occasionally swooping toward a mountain peak where they are intercepted and driven back by a force of good dragons. The evil dragons appear to be hopelessly outnumbered. The dozens of evil dragon corpses revealed by the ebbing tides indicate that the battle is going in the good dragons' favor.

If the PCs don't know what they're looking at, Abriele tells them they are watching the battle at the Isle of Dragons, still in progress. Abriele confirms that the good dragons are easily

winning, but warns that a second tower is on the way. "I have not yet seen it, but I know it is coming.

"But the tower", she continues, "is not the problem. See now an image from the recent past, just after the first tower exploded over Cirulon."

Abriele closes her eyes and goes into another trance. The isle fades and is replaced by a vast, dark swamp. Thousands of bats hang from the limbs of black trees, and a gray mist hangs motionless over the dull, green water. This is the Shadowglades, the birthplace of Khardra, Artha's loathsome consort. (If the PCs participated in the first adventure, they will recognize the Shadowglades; if not, Abriele identifies it for them.)

A dark fog gathers over the center of the swamp. The image of an obese, toadish woman appears inside the fog. The waters under the fog swirl, then spiral high into the air, leaving behind a black hole in the surface of the swamp. An immense, ghostly figure rises from the hole. When it has finally emerged, it looks like a human body nearly 100 feet tall, entirely covered with scales. The toadish woman raises her arms, drawing the ghostly figure toward her. It struggles to resist, but the woman's pull is too strong. She drifts away from the swamp, the ghostly figure trailing behind her.

If the party participated in the first adventure, they recognize the ghostly figure as a gigantic image of Khardra; if not, Abriele identifies him. Abriele also explains that after Khardra's destruction at the Peak of Clouds, his spirit returned to its birthplace, there to spend eternity. Drawing on powerful dark forces, Artha wrenched Khardra's spirit from the swamp and took it with her. Abriele doesn't know where they are now, but she presumes Khardra's spirit will somehow be used to augment Artha's attack on the Isle of Dragons.

Abriele closes her eyes again. A moment later, the swamp is replaced by the previous image of the Isle of Dragons. "As before, the dragons alone will not be able to stop the tower," says Abriele. "The choice is yours to help." If the PCs agree to help, Abriele says she will take them to the tower as soon as they see it approach the island. (If the PCs decline to help, see "Troubleshooting".)

The image below gives Abriele and the PCs a good view of the Isle of Dragons and the surrounding ocean for several miles. The PCs may notice that time passes more quickly in the image (depending on the time of day, they see the reflection of the sun or moons move across the ocean faster than usual). If they ask Abriele about this, she explains that time does indeed pass more quickly on her plane—one hour here equals about six hours on the PCs' plane.

ABRIELE'S ANSWERS

While the PCs wait for the tower to appear, they can talk to Abriele. Abriele gives the following responses, assuming the PCs ask the right questions.

Where are we? "On another plane of existence—one of the infinite planes of the Abyss."

How do you know about the tower and Artha's plan? "I have been watching her, as I have been watching you."

Why didn't Artha use Khardra's spirit to help attack Cirulon? "I can only speculate, but I presume that since the dragons of Cirulon were already weakened from the fading moons, she felt it was unnecessary." (She's right—Khardra's spirit is Artha's ace in the hole.)

Who are you? What is your purpose? Who is the Astral Dragon? Abriele sees no reason to continue to conceal this information from the PCs. Assuming they ask the right questions, she tells them how the good, evil, and neutral dragons parallel the balance among the good, evil, and neutral gods, and just as the neutral gods joined forces with the gods of



good in the All-Saints War, the neutral dragons at one time aligned with the good dragons as a defensive measure against the evil dragons.

The Astral Dragon is the personification of neutrality, an entity that has existed since the beginning of time and to which all dragons—good, evil, and neutral alike—can trace a common ancestry. She resides in a magnificent palace—the dragons' ancestral home on yet another plane of existence—from which evil dragons have been banished. Because the Astral Dragon believes that neutrality must be strictly observed in order to maintain multiversal balance, good dragons are also discouraged from visiting her plane. However, because of the honorable relationship between good and neutral, the good dragons have a special portal which gives them access to their ancestral home.

Is that the portal Artha is looking for? "Yes. She wishes to destroy the Astral Dragon, thereby weakening the bond between good and neutral dragons. She and Takhisis then intend to exploit this weakness like they exploited the weakened bond between good dragons and good people, to enhance their chances of conquering all creation."

Where is the portal? Abriele says nothing.

ABRIELE'S REQUEST

When the PCs have finished asking their questions, Abriele speaks to the PCs.

"I am honor-bound to preserve the balance among good, evil, and neutrality," she says. "The time I have spent in your world has confused my understanding of how best to maintain this balance. By withholding information about the silver disease, many dragons died. On reflection, that seems to have been an evil action, not a neutral one.

"By withholding information about Artha's impending attack on the Isle of Dragons, many more dragons could die. That too seems to be an evil action, not a neutral one. Tell me—is it possible that a neutral action can favor evil?"

Abriele presses the PCs for their opinions. She won't take "I don't know" for an answer—they must tell her if they think a neutral action can have an evil consequence. (If the issue is too deep for this particular group of PCs, make it simpler for them by using the example of the silver dragons. Do they think she did the right thing by withholding her information about the cure? Would they have done the same thing? If not, why not?)

When they have finished giving their opinions, Abriele weighs the party's words carefully, then walks to the edge of the plateau and announces, "The balance has swung too far in favor of evil. The fault is mine. Consider the information I gave you to be another adjustment to that balance."

Abriele suddenly cocks her head, as though listening, then abruptly disappears (she's gone to her lair to attend to her baby—see "Abriele's Secret", below).

ATTACK FROM ABOVE

Five minutes after Abriele vanishes, two large, winged lions with the heads of hawks emerge from a bank of brown clouds above the plateau. They are **hieracosphinxes**, drawn to the plateau by the scent of human flesh. Afraid of Abriele, they have been hoping she would leave so they can feast on the PCs.

The sphinxes will each attempt to make one kill and fly away with the corpse. They swoop low, attacking with their beaks and claws. If one is killed, the other retreats, vanishing into the brown clouds.

If anyone steps over or is pushed off the edge of the plateau, he hovers in mid-air, thanks to the strange laws of phys-

ics in this plane. Anyone can move through the air in any direction as if swimming in water, provided he first makes a successful Dexterity Check. He needs to make the check only once; this indicates he has figured out how to maneuver in the air. Anyone in the air moves at his normal movement rate. (If anyone "swims" down to the surface of the ocean, he discovers it is an icy cold ocean of pure alcohol. Moving to the horizon is fruitless, as the ocean extends for thousand of miles in every direction.)

The sphinxes will not follow the PCs into the hole in the plateau. The hole leads to a winding 30-foot passage ending in a 20-foot-wide pit.

If the PCs don't enter the pit even after dealing with the sphinxes, they hear squealing sounds coming from the hole. If the PCs still don't investigate, Abriele calls to them from the hole. Abriele is in the bottom of the pit, having *teleported* here to attend to her baby.

ABRIELE'S SECRET

The sloping passage leading from the hole is easy to climb down. The pit at the bottom is illuminated by glowing silver stones in the ceiling. The floor of the pit is filled with silver shavings.

Abriele is nestled in the corner of the pit. She cuddles a tiny, hairless **kodragon** against her belly.

Abriele introduces the PCs to her infant, Dira, so young her eyes have not yet opened. Abriele explains that she normally keeps Dira in her pouch; whenever Dira becomes frightened or uncomfortable, Abriele comes here to comfort her. "Aside from myself," says Abriele, "you are the first to see her."

Abriele continues to soothe Dira, then gently replaces the baby in her pouch, saying, "We can now resume our watch."

THE ISLE OF DRAGONS

THE TOWER APPEARS

The second tower arrives at the Isle of Dragons on a night when either Lunitari or Solinari is in high sanction. Regardless of where the moons are when the PCs first arrive on Abriele's plane, note that, according to the Moon Tracking Chart, a high sanction of Lunitari or Solinari can be no more than six days away. Since time goes by six times as fast in Abriele's plane, the longest the party might have to wait for the arrival of the tower is 24 hours.

Abriele keeps a close watch on the Isle of Dragons. On the appointed night, the ocean surface about two miles from the coast of the Isle begins to bubble as if it were boiling. Moments later, a huge black tower sitting atop a chunk of stone bursts through the surface in an explosion of water. The tower floats silently in the air, advancing toward the island. It is virtually identical to the tower that attacked Cirulon. There is no sign of Artha or the spirit of Khadra.

"Is this tower the same as the other?" asks Abriele. (As far as the PCs can tell, it is.) Abriele then asks the PCs how she can help them stop it. Abriele will not participate directly in the battle herself (she won't even *teleport* inside the tower), nor will she take the PCs to the Isle of Dragons. Approaching any of the dragons on the island is also out of the question, as they will not tolerate outside interference.

The best plan of attack is for Abriele to deliver the PCs to the door at the base of the tower, the only visible entrance, just as the good dragons did before in Cirulon. The PCs can then make their way to the observation dome and send the



tower safely out of range. Once this is accomplished, Abriele can pick the PCs up again at the tower door. (If this plan does not occur to the PCs, Abriele will suggest it. Abriele will also go along with any reasonable alternate plan, providing it doesn't require her direct participation, the involvement of good dragons, or taking them to the Isle of Dragons.)

Once the PCs and Abriele have decided on a plan, Abriele uses her breath weapon to *shrink* the PCs. She gestures for the PCs to climb aboard and hold on to her fur. When the PCs are firmly seated, she *plane shifts* once more.

TO THE ISLE

Abriele and the PCs appear high above a roaring ocean. A strong wind blasts salty, tropic air against the PCs' faces; they must clutch Abriele's fur tightly to keep from falling off.

Below them, illuminated by the bright light of the moon, is the isle whose image they have been watching. Dozens of good dragons—gold, copper, bronze, and brass—circle the island; many more are scattered on the beaches and perched on the mountain peaks. A lesser number of evil dragons—red, blue, black, and green—hover off the island, soaring in wide circles, occasionally swooping toward a mountain peak where they are intercepted and driven back. The evil dragons still appear to be hopelessly outnumbered and on the verge of defeat.

The black tower, its wet stone walls gleaming in the moonlight, hovers about two hundred yards above the ocean and advances slowly toward the island. It has already attracted the attention of the good dragons. A phalanx of gold and bronze dragons circles the tower, keeping a safe distance while they size it up.

A shadow blankets Abriele and the PCs, accompanied by the sound of flapping wings. A great bronze dragon drops from above and hovers before them. "Who are you?" demands the dragon. "Why are you here?"

Lei, bronze wyrm: AC 0; MV 9, FI 24; HD 8; hp 40 (reduced due to injuries); #AT 3; Dmg 1-6/4-24/1 -6; SA breath weapon (bolt of lightning 10" x 1/2" or gas cloud 2" x 3" x 3" which *repulses* creatures who fail to save vs. breath weapon for 6 rounds); AL LG; THACO 12.

The dragon, **Lei**, is a look-out who harbors deep mistrust of all Krynn people, including the PCs. She will under no circumstances tolerate their presence on or near the Isle of Dragons. If they speak to her, she ignores them.

Abriele remains calm. "I am Abriele, an emissary of the Astral Dragon. I am here to observe."

"And those little riders of yours. Are they also emissaries of the Astral Dragon?"

"They are my companions."

"Stay clear of the battle. We cannot be responsible for your safety. As for them," Lei motions to the PCs. "see that they stay with you. Their presence is forbidden."

"I understand," says Abriele. "Your defense of the island appears to be holding."

Lei snorts smugly. "We'll drive off the last of them before sunrise."

"If I may ask, what of the tower?"

"What of it? With golden fire and bronze lightning, its remnants will soon rest at the bottom of the ocean."

The conversation is interrupted by the swirl of a dark fog materializing above the tower. An immense image of an obese, toadish woman coalesces in the fog. Above her is the ghostly figure of a human body covered with scales. The figure, nearly 100 feet tall, struggles to free itself, but seems to be gripped tightly by an unseen force.

Artha's voice thunders across the ocean. "Tell me the location of the portal," she says, in her drawling, booming voice. "Tell me or you all will die. You have two hours."

Artha lifts her arms, drawing the struggling figure of Khardra into the dark fog. She embraces the spirit form, "blending" with it. Intense beams of light shoot from all the celestial bodies, drawn directly to their blended images and bathing them in a blinding glow. This "blending" is similar to those which previously dimmed the moons and stars, weakening the good dragons; anyone who participated in the first adventure recognizes the phenomenon.

But something is wrong. The beams of light not only envelop Artha and Khardra, but the tower below them as well. The tower inescapably pulls Artha and Khardra closer and closer, no matter how mightily they struggle against it. At the last, Artha screams, as she and Khardra are sucked through the dome. The tower flares in a blaze of light as ear-shattering shrieks echo through the night air.

The blazing light subsides in a hiss of steam, revealing a monstrously transformed tower which seems to glow as brightly as the sun. Green scales cover the walls, and four huge black tentacles, like those of a gigantic octopus, extend from the sides, writhing in the wind. The tower rhythmically expands and contracts as if it were breathing. There is no sign of either Artha or Khardra. The tower begins lurching toward the isle in a series of slow jerks.

The dragons circling the tower have drawn back, frantically blinking their eyes. No dragon appears able to come within 100 yards of the tower. Even the evil dragons avoid the glowing tower. Lei abandons her interrogation to dive toward the tower, but withdraws before coming within 100 yards.

Abriele has no better idea than the other dragons of what has just occurred. "The choice is yours," she says to the party. "Do you still wish to proceed?" If the answer is yes, Abriele *teleports* them to the tower entrance (see Level 1 in the Encounter Key below). If they hesitate, see "Trouble-shooting".

EFFECTS OF THE LIGHT

The brilliant light of the tower is especially harmful to dragons, including evil dragons. If a dragon looks at the tower from within 200 yards, he must save vs. spells. If the roll succeeds, he is blinded for the next 2d6 hours and suffers 1d6 hp of damage. If the roll fails, he is permanently blinded and suffers 2d6 hp of damage.

Other creatures are not affected as severely. If Abriele, a kodragon, looks at the tower for a full round, she must make the same roll, and suffer the same penalties, as a dragon. For the PCs, staring at the tower is comparable to staring at the sun. Characters foolish enough to stare at the tower from a distance of 200 yards or less for a total of 10 rounds (not necessarily consecutive rounds) must save vs. spells (with a -2 penalty). If the roll succeeds, they are blinded for 2d6 hours; if it fails, they are permanently blinded.

The light completely envelops the tower and acts as a permanent *wall of force*. Attacks directed against the tower itself are made at -4. Figure that any 2-foot-diameter area has 50 hit points and is AC 8 (before the -4 penalty).

Because of the overpowering light, the air around the tower is also extremely hot and especially dangerous to dragons. Dragons within 200 yards of the tower have a 30% chance per round of suffering 1d4 hp of damage (no saving throw allowed). Getting closer increases the danger. Dragons within 100 yards of the tower have a 30% chance per round of suffering 2d4 (rather than 1d4) hp of damage. Dragons within 50 yards of the tower have a 50% chance per round. The PCs aren't affected as dramatically by the heat. For every three consecutive rounds a PC spends within 100 yards of the tower, he must make a successful Constitution Check or suffer 1d6 hp of damage. If the three consecutive rounds are



spent within 50 yards of the tower, this check is made at -2.

Characters inside the tower suffer no effects from the light or the heat.

THE TRANSFORMED TOWER

When Artha attempted to blend with the spirit of Khardra, the unleashed forces reacted with the enchantments already present in the tower. The tower absorbed the essences of Artha and Khardra, transforming itself into a supernatural blend of organic and inorganic matter. Artha had no idea this would happen.

Now integral parts of the tower, Artha and Khardra are only dimly aware of what's happened to them and what's going on around them. Neither has control of the tower; the tower continues toward the island in compliance with its most recent command (see "Observation Dome", below, for details).

Like the tower that attacked Cirulon, this tower is a former prison consisting of four levels and an observation dome. It has similar features to the first. If the PCs explored each level of the first tower, they will find themselves on familiar territory here.

The tower sits atop an immense chunk of rock which was uprooted when the enchantments from the evil mages and clerics caused it to rise. The entrance door at its base is the only access to the tower. (There is no secret door in this tower.)

The following information also applies to the tower:

— Powerful enchantments cause the tower to fly and will cause it to explode in two hours (see "Explosion", below). Flight is controlled from the observation dome. Artha has already triggered the enchantment that will cause the tower to explode. Neither its flight nor the explosion are affected by *dispel magic* or similar spells.

— The interior of the tower is dark. There are no windows. Except where otherwise indicated, the tower walls are stone and the floors and doors are wood. Both the walls and floors continually pulsate in and out as if they were breathing, once a minute.

Because the tower has been under the ocean, every interior surface is wet with sea water. Algae and seaweed cover the floors.

The interior of the tower is humid and cool. The entire tower reeks from the combination of salty sea water and rotting meat.

The tower lurches a few feet forward every few seconds, moving about one mile per hour. The lurches feel like mild tremors to its occupants. With every lurch, agonized moans reverberate throughout the tower. There is no apparent source for the moaning.

— Movement between levels is by rope ladders hanging from the higher level.

— Throughout the tower are slits in the walls, floors, and ceilings called Vocal Orifices, created when the tower transformed. A Vocal Orifice does not appear until someone comes within 10 feet of it. A section of the wall (or floor or ceiling—see Map 5) splits apart in a glistening black rip about 3 feet wide and 2 inches deep.

Once an Orifice appears, it speaks, repeating the same phrase over and over about ten times louder than normal speech. The voice continues until everyone moves to a different level or it is plugged up; an Orifice can be plugged with seaweed, clothing, or any similar material. *Dispel magic* or similar spells can also silence a Vocal Orifice. It is impossible for the party to communicate with an Orifice; only other-planar creatures (like Abriele) can do so.

The Vocal Orifices are infused with the blended conscious-

nesses of Artha and Khardra and speak in one or the other's voice. Artha's voice is a slow, deep drawl. Khardra's voice is raspy and hissing. The PCs will recognize Artha's voice from other encounters in this adventure. Those who participated in the first adventure will also recognize Khardra's voice.

When an Orifice appears, roll 1d20 on the following table to determine the phrase it repeats. The name in parentheses indicates the voice. If the same Orifice is activated a second time, roll for a new phrase.

Vocal Orifice Table

Roll	Repeated Phrase
1-2	"Mother!" (Artha)
3	"Khardra . . . you are mine!" (Artha)
4	"I'll kill you!" (Artha)
5	"Who did this?" (Artha)
6	"You are mine . . ." (Artha)
7	Shrieks of agony. (Artha)
8	"Where is the portal?" (Artha)
9	"The portal . . ." (Artha)
10	"Kill the dragons!" (Artha)
11	"What's happened to me?" (Khardra)
12	Snake-like hissing. (Khardra)
13	"Artha . . . free me!" (Khardra)
14	"Set me free!" (Khardra)
15	"Don't kill me again . . ." (Khardra)
16	"Who did this?" (Khardra)
17-18	Screaming and moaning. (Both Artha and Khardra—two voices speak from the same Orifice)
19-20	Roll once for Artha (1d10) and once for Khardra (1d6 + 10); two voices speak from the same Orifice.

— Make sure the PCs understand that they have two hours to stop the tower. The following effects occur over the course of those two hours:

During the First Half Hour. The tower walls are warm to the touch.

Second Half Hour. The temperature inside the tower has risen above 90 degrees. The stone walls are hot, though not enough to cause damage. Steam rises from the wet floors.

Third Half Hour. The temperature is even higher, and the pulse rate of the walls and floors doubles (two pulses a minute).

Fourth Half Hour. Walls are extremely hot; touching one with exposed flesh, such as a bare hand, causes 1 hp of damage. Dry wood smoulders and smokes. Water pools boil. The walls and floors still pulsate twice a minute. All of the Vocal Orifices on levels other than the level the PCs occupy shriek in pain.

When two hours have passed, go to "Explosion".

TOWER ENCOUNTER KEY (MAP 5)

I. FIRST LEVEL

The first level of the tower was used to dispose of the bodies of dead prisoners.

1a. Entry Door. Abriele and the PCs *teleport* in front of the entry door to the tower. The heat is nearly suffocating. Remember that for every three consecutive rounds a PC spends within 50 yards of the outside of the tower, he must make a successful Constitution Check at -2 or suffer 1d6 hp of damage.

Abrielle tells the PCs she'll pick them up here in exactly two hours. She tells them this even if they made different arrangements previously. Before the PCs can respond, she *plane shifts* away.

The wooden entry door has been smashed to pieces. (The culprit was the giant eel (1d).)

1b. Corridor of Spiracles. The walls, floor, and ceiling of the north-south section of this corridor are lined with breathing holes called spiracles, created when the tower transformed. The spiracles are about 6 inches in diameter and 3 inches deep. They randomly open and close as if they were breathing. Each time a spiracle opens, it spews a stream of steam, black mist, or nauseating gas into the corridor.

There are well over a hundred spiracles in the corridor. Though it is easy to avoid touching or stepping on them, they are stimulated by movement, especially rapid movement.

As each character moves down the corridor, ask him how fast he is moving. The chance of being spewed on by a spiracle is as follows:

less than ¼ normal movement rate:	5%
¼ to ½ normal movement rate:	10%
more than ½ normal movement rate:	20%
Higher than normal movement rate:	30%

The north-south corridor is divided into three sections (see map). Check for a spiracle spew each time someone enters a new section. A PC may change his movement rate in each new section.

If someone is attacked by a spiracle, roll 1d6 and consult the following table for the effect. Only the person triggering a spew is affected by it, but all effects are cumulative.

Roll	Result
1-2	Steam (1d4 hp of damage)
3-4	Black mist (save vs. poison or become blind for 1d6 rounds)
5-6	Nauseating gas (Successful Constitution Check or suffer 1d4 hp of damage)

1c. Exit ladder. At the northeast end of this corridor is a ladder hanging down from above. A mass of seaweed, algae, and other debris washed in from the ocean has collected here, completely filling the area at the base of the rope ladder.

Concealed in the debris is a dead Portuguese man-o-war. Since it is transparent, there is a 90% chance it is undetected unless the character looking is able to detect invisible objects. Anyone who touches the debris with bare flesh has a 50% chance of touching one of the man-o-war's 20 tentacles. The PC must save vs. poison and vs. paralyzation. If he succeeds vs. poison, he takes 1d2 hp of damage; if he fails, he takes 2d4 hp of damage. If he fails vs. paralyzation, he is paralyzed for 1d4 hours.

If anyone probes the debris with a staff or other object, there is a 20% chance per round of probing that he will stimulate a tentacle. The reflex movement of a stimulated tentacle should alert him that something is alive inside the debris. The PCs can then move the man-o-war aside with staves or other objects, being careful not to touch it with their hands, and avoid being stung.

Inside the man-o-war is the skeleton of a Dargonesti (sea elf) and a *ring of warmth*.

1d. Disposal Pit. The door has been severely battered, so that it is barely hanging on its hinges.

If the PCs open the door, they are greeted with a nauseating stench of decay, so powerful that it causes eyes to water. Anyone within 10 feet of the door must make a successful Constitution Check or lose 1 hp of damage.

This room is a large pit, dug about 4 feet into the bedrock. Bodies of dead prisoners were dumped here through a trap

door in the northeast ceiling. The room is now filled with sea water, refuse and remains floating on the surface.

While the tower traveled underwater, a **giant eel** broke through the entry door and the door to this room, intending to use it as a new lair. When the tower became airborne, water leaked out, leaving only this pool. The terrified eel is in a decidedly bad mood.

The eel is currently submerged, motionless on the bottom of the pool. It attacks anyone who enters the water. As long as anyone is in the room, it fights to the death. It cannot leave the room.

If the PCs dispose of the eel, they can search the pit for treasure by groping in the muck along the bottom. For every 10 minutes someone gropes in the muck, there is a 20% chance he finds one of the following items: human skull (no value), broken bone (no value), short sword, clam (pearl inside worth 200 stl), glass flask containing two doses of *potion of water breathing*, iron treasure chest (containing 400 sp, 250 gp, 200 stl, and a ruby worth 2,500 stl).

At the end of every 10 minutes of searching through the muck, the PC must make a successful Constitution Check, or lose 1 hp.

2. SECOND LEVEL

The second level of the tower was used to interrogate prisoners.

As soon as anyone enters this level, he hears loud pounding on the wall (at the X on the map) coming from outside the tower. This is one of the tower's tentacles trying to break in. The pounding continues for 10 consecutive rounds. On round 10, the tentacle breaks through.

The tentacle is black, leathery, and has a reach of 40 feet. It swings wildly through the corridor, but it cannot reach the westernmost end of the corridor, nor can it reach inside rooms 2b or c.

Each round, there is a 6% chance that any exposed character (those characters not in a room or not out of reach in the west end of the corridor) will be struck by the flailing tentacle. Each tentacle strike causes 1d6 hp of damage. Roll for each character exposed—more than one can be struck in a round.

The tentacle has an AC of 2; its relatively high AC is due to its tough hide and constant movement. It is destroyed if it takes 50 hp of damage.

If everyone leaves the corridor for 10 consecutive rounds, the tentacle withdraws. However, it will reappear three rounds after anyone reenters the corridor.

2a. Corridor. The hole at the northeast end of this corridor has a ladder leading down. Near this hole is a trap door with an iron ring. The door opens easily and leads to the eel pool below (1d). At the southeast end of the corridor is a hole in the ceiling. A ladder dangles through this hole.

The floor inside the dotted line is extremely rotten. Anyone entering this area has a 75% chance of falling through the floor. If he succeeds in a Dexterity Check with a $\$-1$ penalty, he catches himself before falling all the way through. Anyone who falls completely through the floor lands in the eel pool (1d). If the eel is still there, it attacks and fights to the death.

The PCs can avoid the rotten floor by standing outside the dotted line, hooking the ladder with a staff or similar object, and pulling it to them.

2b. Interrogation Room. The door to this room is secured by a special combination lock consisting of several levers and wheels. The door is enchanted by a permanent *wall of force* spell to prevent it from being destroyed. (These extraordinary security measures were installed by the mage who served as the prison's chief interrogator. He routinely confiscated treasures from prisoners. Rather than turn the treasures



over to his superiors, he hid them in this room.)

Anyone with an Intelligence score of 15 or higher can attempt to open the lock. He has a base chance of 5% per round of succeeding. For every point of intelligence above 15, add another 3%. For every consecutive round of fiddling with the lock, add another 3%. A PC with *pick locks* skill doubles these percentages. (For instance, a PC with an Intelligence of 16 has a 14% chance of opening the lock on the third consecutive round. If he tries for another round, he has a 17% chance.)

Inside this room is an assortment of manacles, chains, stone tables, braziers, iron pokers and other grisly equipment, all of which were used by the prison guards to interrogate prisoners. A ceiling hole near the north wall has a ladder leading up.

In a large basket in the northwest corner is a 100 lb. iron chest secured with *wizard lock*. The chest contains 12 white diamonds (5,000 stl each), a jeweled silver necklace (6,000 stl), a steel and ruby ring (8,000 stl), and a platinum and emerald bracelet (12,000 stl).

2c. Lock-Up. This room was at one time used for solitary confinement. It now contains two **exploding skeletons**.

The door to this room is locked. If the PCs are unable to *pick locks*, they must inflict 20 hp of damage on it to break it open.

While the PCs are trying to open the door, or if there are loud noises in the corridor outside of this room, scratching and clawing noises come from the door, as if something inside was desperately trying to get out. If the PCs open the door, the skeletons lunge at them.

The skeletons fight until destroyed, but will not pursue to a different level of the tower. If the PCs didn't break down the door, they might close it again, preventing any skeletons still inside from escaping.

Note that the eastern section of this room is also within the dotted line designating rotten floor. As with the corridor, anyone who enters this area has a 75% chance of falling through the floor. If he succeeds in a Dexterity Check with a -1 penalty, he catches himself before falling all the way through. Anyone who falls completely through the floor lands in the eel pool (1d). If the eel is still there, it attacks and fights to the death.

There is nothing of value in this room.

3. THIRD LEVEL

This level contains the cells used to confine the tower's prisoners.

The ceiling of this level is slimy and sticky, due to the secretions seeping through from the level above. Seaweed, algae, and other ocean debris is stuck tight to the ceiling. Touching the ceiling is not harmful.

As soon as anyone enters this level, he hears loud pounding on the wall (at the X on the map) coming from outside the tower. This is another one of the tower's tentacles trying to break in. The pounding continues for 10 consecutive rounds. On round 10, the tentacle breaks through.

The tentacle is black, leathery, and has a reach of 60 feet. It swings about wildly. Since the roof of the solitary confinement room (3c) is lower than the ceiling, the tentacle can reach anywhere in the corridor. However, it cannot reach through the cell bars or into the solitary confinement room (3b-e).

Each round, there is a 6% chance that any exposed character (any character in the corridor) will be struck by the flailing tentacle. Each tentacle strike causes 1d6 hp of damage. Roll for each character exposed—more than one can be struck in a round.

The tentacle also has an AC of 2 and 50 hit points.

If everyone hides in the solitary confinement room (3c) or leaves the level for 10 consecutive rounds, the tentacle withdraws. However, it will reappear in three rounds if anyone returns to the corridor. The tentacle does not withdraw if anyone hides in a cell.

3a. Corridor. There are four exits from this level, two up and two down. The two floor exits are in plain sight, in the northwest and southeast corners of the room.

The northwest ceiling hole is not clearly visible. The ladder has been drawn up onto the next level, and the opening is hidden behind the seaweed and sticky secretions which cover the entire ceiling. The PCs may remember the approximate location of this opening from their explorations of the tower that attacked Cirulon. If they probe the ceiling in this area, there is a 25% chance per round of probing that they will locate the ladder. They can then hook the ladder with a staff or similar object and pull it down.

The ladder dangling from the hole in the southeast corner of the ceiling is covered by a tangle of what appears to be seaweed, but is actually **strangle weed**.

3b. West Cell. This cell is bound by iron bars. Its door is locked. If the PCs are unable to *pick locks*, they can use an improvised pry bar (an axe, for instance) to pry the rusty lock open. It takes a successful Strength Check with a -2 penalty. If two PCs pry together, the PC with the highest Strength makes the Strength Check (with no penalty).

The cell contains a half-dozen wooden buckets, a half-dozen cots, and a garbage pile against the north wall. There is nothing of value.

3c. Solitary Confinement. This windowless room has stone walls and a heavy, locked wooden door. The door sits on a one-foot stone threshold. If the PCs are unable to *pick locks*, they must inflict 20 hp of damage to break it open.

This room was used to confine unruly prisoners. It is now filled with a pool of water as high as the threshold, and contains a **water weird**.

The water weird forms two rounds after anyone enters this room, appearing as a transparent serpent. It immediately lashes out. If it hits someone and that person fails to save vs. paralyzation, he is dragged into the water, face down. Unless the water weird is disrupted, it holds its victim in the water until he drowns.

After a PC has been held in the water for three rounds, he must make a Constitution Check each round to see if he continues to survive. The first check (in round 4) is made normally, but each successive check is made at -2. The modifiers are cumulative; that is, the second check is made at -2, the third at -4, and so on.

If anyone searches this room, he finds a *brooch of shielding* (absorbs up to 101 hit points of *magic missile* damage before melting and becoming useless) under the water in the northeast corner.

3d. South Cell. The contents of this cell are similar to those in the west cell—cots, buckets, and a garbage pile in the southwest corner. The door is locked, but can be opened like the west cell door.

There is nothing of interest here.

3e. East Cell. The contents of this cell are similar to those in the west and south cells—cots, buckets, and a garbage pile in the southeast corner. The door is unlocked.

Under the cot in the northeast corner is a key ring and a piece of parchment. The key ring has keys to all the cells on this level. The parchment is covered with strange diagrams and numbers. Anyone who has examined the lock on the interrogation room (2b) and succeeds in an Intelligence Check recognizes this as the combination for opening that lock. Anyone using this parchment can open that lock in one round.

4. FOURTH LEVEL

This level contains the living quarters for the prison guards, plus a storage area. The entire floor of this level is sticky and spongy, a result of the tower's transformation. Seaweed, algae, and other ocean debris covers the floor. The sticky surface reduces movement to half normal rates.

As soon as anyone enters this level, he hears loud pounding on two of the walls (at the Xs on the map) coming from outside the tower. These are the last two of the tower's tentacles trying to break in. The pounding continues for three consecutive rounds. On the third round, the tentacles break through.

The tentacles are black, leathery, and have a reach of 60 feet. They swing wildly through the room. On the first round of swinging, they smash all three living quarters (4b-d), releasing the skeletons and activating the giant spiracle (4e).

There is no safe place for anyone to hide from the tentacles on this level. Each round, there is a 10% chance that any character or skeleton will be struck by a flailing tentacle. Each tentacle strike causes 1d6 hp of damage. Roll once for each character or skeleton—more than one can be struck in a round, but none will be struck twice in a round.

These tentacles also have an AC of 2 and 50 hit points. They will not withdraw from this level once they've broken through the walls.

4a. Central Area. There are holes in the northwest and southeast corners of the floor. The northwest hole has a ladder bunched on the floor beside it. A ladder dangles from a ceiling hole in the center of this area.

4b, c, and d. living Quarters. These are identical living quarters formerly used by the tower personnel. Each contains bed rolls, filthy blankets, a table, several chairs, and three **exploding skeletons**.

As explained above, the fragile wooden walls of these quarters are shattered on the first round the two tentacles break inside the tower here. With their rooms destroyed, the skeletons attack the PCs on sight. The skeletons fight to the death, but will not pursue the PCs to a different level.

The skeletons will not attack the tentacles. However, note that the tentacles have the same chance of attacking a skeleton as they do anyone else.

The powerful magic that transformed the tower also affected the skeletons by infusing them with the draconian essence of Khadra. If a skeleton is reduced to 0 hit points, its bones explode, causing 1d6 hp of damage to all within 10 feet (no saving throw).

If anyone finds the time, he can search for treasure. For every 5 rounds someone spends searching, there is a 50% chance he finds one of the following items: wooden skeleton key (homemade and worthless), *short sword +1*, long bow with no string, bag containing 55 sp, bottle of herring wine, volume of poetry written by Crouse the Sensitive.

4e. Giant Spiracle. This former storage room was changed into a breathing hole called a spiracle when the tower transformed. The spiracle is about 10 feet in diameter and 3 feet deep, and is located on what was originally the north wall of the storage room. The interior of the storage room is now solid tissue, similar in texture to a moist sponge.

If the PCs inflict 25 hp of damage on the spiracle (consider it to have an AC of 5), it is temporarily destroyed. It regenerates 1d6 rounds later and resumes spewing immediately.

As mentioned above, the spiracle activates as soon as the two tentacles break inside the tower. The spiracle opens and closes as if it were breathing. Once per round, it spews a cone of gas into the room. A short gas cone has a base 10 feet wide and a length of about 10 feet. A long cone is about three times as long and wide.

Each round, roll 1d8 and consult the table below for the type and size of gas cone. Only PCs within the area of the cone suffer the effects. All effects are cumulative. The skeletons and tentacles are unaffected.

Roll	Gas Cone
1	Small steam (1d4 hp of damage)
2	Small black mist (save vs. poison or become blind for 1d6 rounds)
3	Small nauseating gas (Successful Constitution Check or suffer 1d4 hp of damage)
4	Small rotten grain odor (no effect)
5	Large steam (1d4 hp of damage)
6	Large black mist (save vs. poison or become blind for 1d6 rounds)
7	Large nauseating gas (Successful Constitution Check or suffer 1d4 hp of damage)
8	Large rotten grain odor (no effect)

5. OBSERVATION DOME

There is a fleshy lip running around the central hole, rising about 2 feet above it. The walls, ceiling, and floor of this room are covered with red, pulsating jelly that smells like rotten meat. In the center of the room is a raised platform with two 3-foot-tall pedestals 3 feet apart. A glowing black globe sits atop each pedestal. There are two black disks between the pedestals. There is no sign of life in the room.

This is the control area for the flying tower. The fleshy lip and jellied walls are another side-effect of the tower's transformation—the lip keeps the jelly from flowing down into the lower levels. Anyone walking in the jelly sinks to his knees and can move at only 1/4 of his normal rate. The jelly has no harmful effects.

All of the Vocal Orifices throughout the tower activate as soon as anyone enters this room. All endlessly repeat the word "Mother" in Artha's voice, as if she were pleading for mercy.

The tower responds to the mental or spoken commands of its pilot. Someone must stand on the black disks, place his hands on the globes, then think or speak the direction and speed he wishes the tower to travel. The tower can travel any direction, including up and down, and can move at speeds up to 10 miles per hour. This tower maintains the direction and speed commanded until given another order, even if the pilot leaves the controls. (For instance, if the pilot ordered the tower to head away from the isle at top speed, it would carry out its orders even if the pilot left.)

As soon as someone stands on the black disks to take over as pilot, two hands emerge from the jelly and tighten around his ankles. A creature with filthy hair and glowing red eyes pulls himself from the jelly and attacks the new pilot. The creature, a **juju zombie**, has rotten, gray flesh and is covered from head to toe with reddish slime.

The zombie was the former pilot of the tower. He was knocked into the jelly when the tower transformed. He will fight until destroyed, pursuing to other levels of the tower if necessary. The new pilot is the zombie's primary target.

If someone takes over as pilot and issues new instructions to the tower, the Vocal Orifices stop speaking. A moment later, they begin again, this time loudly cackling in Artha's voice, "The portal is mine! I have found the portal!" All Orifices in the tower endlessly repeat these phrases in unison. (Artha's discovery of the portal is not a coincidence; see the Epilogue for details.)



EXPLOSION

If the PCs managed to change the direction of the tower, they will have to find a safe place to spend what's left of the two hours before Abriele comes to fetch them (the Observation Dome, although somewhat messy, is perfectly safe except for the zombie). When exactly two hours have passed, Abriele appears at the tower doorway.

If two hours have passed before a new pilot redirects the tower, all of the Vocal Orifices begin loudly cackling in unison, "The portal is mine! I have found the portal!" in Artha's voice.

When Abriele appears, she is distracted and nervous. If no one is at the tower door, she can faintly be heard shouting, "Quickly! We must leave!" When the party appears, she *shrinks* them with her breath weapon, then gestures for them to climb aboard. When they are firmly seated, she *teleports* high above the tower.

Even from this distance, they can hear the screams of the tower. Vocal Orifices have now opened on the outer walls, all screaming in Artha's voice, "The portal is mine! I have found the portal!"

The good and evil dragons have stopped fighting and are watching the tower in fascinated horror as it continues to lurch toward its destination. The tower shakes violently, and chunks of the rock base crumble and drop off.

What happens next depends on whether anyone made it to the Observation Dome and changed the tower's route.

If the tower's route was changed. The tower lurches away from the Isle of Dragons, heading toward the open sea (or wherever it was sent) where it explodes in a ball of fire. (The enchantment causes the tower to act as a momentary conduit to a hellish plane of the Abyss, drawing in hellfires of awesome power and magnitude.) The fireball seems to blaze as brightly as the sun, then collapses in a cloud of black ash.

The image of Artha materializes in the smoke of the blast, then shoots into the heavens, heading toward Lunitari. Khardra's spirit trails behind, struggling to resist, but Artha's pull is too strong.

If the tower was sent at least a mile away from the isle, nothing there is harmed in the blast. Any good or evil dragon unfortunate enough to be caught within a half-mile of the blast radius is evaporated in the flames. Any good dragon caught within a mile to a half-mile of the blast radius is seriously wounded from the flames and spirals to the safety of the Isle of Dragons; evil dragons plunge into the ocean.

If the tower's route was not changed. The tower lurches toward the Isle of Dragons. As soon as it is over the island, it drops like a stone, exploding in a ball of flames. (The enchantment causes the tower to act as a momentary conduit to a hellish plane of the Abyss, drawing in hellfires of awesome power and magnitude.) The fireball seems to blaze as brightly as the sun, then collapses in a cloud of black ash.

The image of Artha materializes in the smoke of the blast, then shoots into the heavens, heading toward Lunitari. Khardra's spirit trails behind, struggling to resist, but Artha's pull is too strong.

The explosion rips a gaping, jagged hole in the isle nearly a mile in diameter that fills with flames. Though many dragons manage to escape the force of the explosion, dozens of dragons, good and evil alike, are evaporated in the blast, and dozens more are seriously wounded.

AFTERMATH

After the tower explodes, the surviving evil dragons scatter, flying as fast as they can in every direction to escape the wrath of the good dragons.

The surviving good dragons ignore the fleeing evil dragons. Some good dragons remain on the isle to attend to their wounded comrades, but most soar into the sky, pursuing Artha and Khardra to Lunitari.

While this scene unfolds, Abriele hovers in silence, ignoring any questions or comments. As the last of the good dragons disappear into the clouds, Abriele *plane shifts*, back to the Meadow of Violets.

TROUBLESHOOTING

Here are some tips for handling unexpected problems:

If the PCs don't mention Abriele's corn to the Council of Cirulon. One of the council members—possibly Strato or Alcuin—might have observed portions of the PCs' adventures with the Wemitowuk on a *disk of history* and saw them explore the mouldy corn field. The Council asks the PCs how they knew about the corn.

If the PCs failed their mission on Schallsea. If the PCs didn't discover the cure for the silver disease, the Council of Cirulon thanks them for their efforts but does not make them honorary citizens. The rest of the scene with the Council plays out as described, as Abriele confesses to having induced Tertullian's dream and withheld the cure.

If the PCs won't go with Abriele or refuse to attack the tower. Abriele might have them experience visions of the good dragons dying in flames from the black tower, then tell them they have a chance to prevent the deaths if they so choose.



EPILOGUE

THE MEADOW OF VIOLETS

Abriele and the PCs appear in the meadow from the Prologue. Abriele uses her breath weapon to *cancel shrinking* and they become their normal size. A warm breeze caresses the tall grass of the meadow. Above, hundreds of stars twinkle in the clear sky. All is silent.

Abriele hovers about four feet from the ground, staring into the night sky. "More lives will be lost," she says, her voice heavy with sadness. "The forces of evil now know the location of the portal. As do you, presumably."

Though the PCs may have their suspicions—they may have noticed the lights on the map of Lunitari in the Cirulon Map Room (Location 13), and they just saw Artha streaking toward that moon—it is unlikely the PCs know the location. If they ask Abriele, she hesitates, then says sadly, "It is clear that it is a secret no longer. The portal to the plane of the Astral Dragon is located on the neutral moon of Lunitari. It has been undisturbed for eons. Until now. Thanks to—" She cuts herself off.

If the PCs press for details or ask how Artha discovered the location of the portal, Abriele says nothing.

She then turns to the PCs. "You have proven yourselves to be wise, courageous and compassionate. You have made my decision an easy one.

"There are gifts from the Council of Cirulon over the next hill, a reward for your efforts on their behalf. I will return momentarily." She abruptly vanishes before anyone can speak to her. (Abriele is leaving to say good-bye to her child—see "The Adventure Continues" for details.)

REWARDS

Note to the DM. If the PCs did not stop the tower from exploding over the Isle of Dragons, they receive only the first gift. Otherwise, they receive both gifts.

First Gift. When the PCs reach the top of the hill, a white cloud materializes over their heads, then floats gently to the ground. The cloud dissipates, revealing several steel globes (one globe per PC). The globes of Cirulon are about 4 inches in diameter and are imbedded with chips of gold, copper, silver, brass, and bronze in intricate patterns. The globes rest on small pillows (of Density 3 cloud material). Each *globe* belongs to a specific PC. Each PC can locate his *globe of Cirulon* by touching it; the owner's touch causes it to glow. Touching the *globe* acts as a *potion of healing*; this effect occurs once per day and affects only the owner.

Second Gift. After the PCs have examined their *globes of Cirulon*, they hear a flutter of wings above them. A pegasus lands in front of each PC.

Each pegasus will serve his chosen to the death. The pegasus nuzzle the PCs, then soar away into the night sky. Each PC realizes that he can summon his pegasus simply by returning to this hill any night.

FINALE

When the PCs have finished examining their gifts, Abriele abruptly reappears. She avoids eye contact with them and instead stares into the sky.

She finally speaks softly, her voice shaking. "I have heard much about the bond between good dragons and good peo-

ple. Your actions have made it stronger. I do not know how your bond with the dragons obligates you, but I know your aid is still needed.

"I speak not for the dragons, now or perhaps ever again. I ask this only of myself—do you wish to continue?"

Abriele will not explain exactly what type of aid is needed, nor will she explain her own plans, where she just came from, or what's happening on Lunitari.

Choose one of the following two endings, depending on whether the PCs wish to continue.

The Adventure Ends Here. If they don't wish to continue, Abriele nods her head in agreement. "I understand. I will look elsewhere for aid. Perhaps choosing to do nothing is the wisest choice of all. It was foolish of me to interfere. Every choice I made to maintain the sacred balance is a choice I now regret.

"It was I who told Artha the location of the secret portal — yet one more choice I now regret.

"Now I must face the consequences. Farewell."

With that, Abriele *plane shifts*, leaving the PCs alone under a silent sky of twinkling stars.

The Adventure Continues. If the party wishes to continue, Abriele nods in agreement. She *shrinks* them and motions for them to climb aboard and hold on to her fur. When they are firmly seated, she *plane shifts*, and they appear a moment later atop the broad column on Abriele's home plane. She uses her breath to *cancel shrinking*, and then walks to the plateau's edge and stares into the ocean.

"Meeting you has been a profound experience," she says solemnly. "I know you will not betray my trust. Farewell." With that, she *plane shifts* and disappears.

Within a few minutes, the PCs hear the mournful cries of Abriele's baby coming from the hole in the plateau. If they investigate, they find the tiny, hairless kodragon squirming in a nest of silver shavings. Beside the tiny kodragon is a red tablet, one of the tablets Abriele carries.

A message has been etched neatly in the tablet:

"It was foolish of me to interfere. Every choice I made to maintain the sacred balance is a choice I now regret.

"It was I who told Artha the location of the secret portal — yet one more choice I now regret.

"Since I have repeatedly violated my obligation to maintain the sacred balance, I must accept the consequences of my choices. I am willing to face the wrath of the Astral Dragon, but I am not willing to risk the life of my child to do so. I know you will care for her.

"I will send someone for you."

UNANSWERED QUESTIONS

Though the adventure has ended, questions still remain.

— What will happen to Abriele? What will happen to her baby? And the PCs?

— What are Artha and Khardra's new plans? How does Takhisis fit in?

— What dangers face the good dragons on Lunitari?

— Exactly who—or what—is the Astral Dragon?

If you don't plan to continue with this series, you may wish to answer these questions in adventures of your own design. Otherwise, these and other questions will be explored in the final module, *Dragon Keep*.



EYEWING

CLIMATE/TERRAIN:	The Abyss (preferred)
FREQUENCY:	Rare
ORGANIZATION:	Band
ACTIVE TIME:	Any
DIET:	None known
INTELLIGENCE:	Low (5-7)
TREASURE:	Nil
ALIGNMENT:	Lawful Evil

NO. APPEARING:	1d20
ARMOR CLASS:	4
MOVEMENT:	Fl 24
HIT DICE:	3
THACO:	16
NO. OF ATTACKS:	3 or 1
DAMAGE/ATTACK:	1d6/1d6/1d4 or special
SPECIAL ATTACKS:	Tears (see below)
SPECIAL DEFENSES:	See below
MAGIC RESISTANCE:	Nil
SIZE:	L (15' wingspan)
MORALE:	Very Steady (13-14)
XP VALUE:	650

Eyewings are loathsome inhabitants of the Abyss. They are obedient, loyal, and dumb, perfect servitors for any who wish to control or intimidate their fellow creatures. Eyewings often appear in a wing of three—a wing leader, who is slightly more loyal to or fanatical about their chosen master, and two more flunkies who are usually a bit larger and even less intelligent than the leader.

An eyewing's body is an oval ball of matted black fur about 5 feet wide. The body is dominated by a single, bulging 4-foot wide eyeball. The eyeball is black with a blood-red pupil that continually leaks bluish fluid. Leathery bat wings, each 5 feet long, extend from the body. Each wing ends in three razor-sharp talons. An 8-foot rat's tail hangs limply below.

Combat: Eyewings fight by swooping down on a target and attacking with their claws and tail. An eyewing can also hover and blink *eyewing tears* on a target 100 feet or less beneath them (the same chance to hit as a normal attack). Those struck directly by an *eyewing tear* must save vs. poison. Those succeeding suffer 1d6 hp of damage. Those failing suffer 2d6 hp of damage. The tears also splash in a 10-foot radius. Those splashed by an *eyewing tear* must also save vs. poison. Those succeeding suffer 1d4 hp of damage. Those failing suffer 2d4 hp of damage.

Other Notes: *Eyewing tears* harden into rubbery lumps 2d6 hours after an eyewing releases them. Those coming in contact with this substance must save vs. poison or suffer 1 hp of damage from a burn.

Eyewings have *infravision* and *ultravision* and can see with perfect accuracy for distances up to 25 miles. They are immune to all cold-based attacks. If an eyewing is killed, its eye darkens, then turns black.

While on the Prime Material Plane, eyewings fly constantly—there is no record of one ever having landed. It is assumed that they maintain this practice while on the Abyss and other planes. Similarly, there is no indication that they require food, water, or air.

KANI DOLL

CLIMATE/TERRAIN:	Rural societies
FREQUENCY:	Rare
ORGANIZATION:	Nil
ACTIVE TIME:	As per enchantment
DIET:	Nil
INTELLIGENCE:	Nil (0)
TREASURE:	Nil
ALIGNMENT:	Chaotic Evil

NO. APPEARING:	2d6
ARMOR CLASS:	10
MOVEMENT:	8
HIT DICE:	2
THACO:	16
NO. OF ATTACKS:	1
DAMAGE/ATTACK:	1d4
SPECIAL ATTACKS:	Continuous bite
SPECIAL DEFENSES:	Nil
MAGIC RESISTANCE:	Nil
SIZE:	T (about 6" tall)
MORALE:	Fearless (never checks)
XP VALUE:	35

In their usual form, *kani* dolls are simply good-luck or power charms with no life of their own. However, when the making of one is perverted to evil, the result is a chillingly relentless hunter.

Kani dolls can be made of any substance, but most are made of wood, cloth, feathers, grass, and other cheap, easily available materials. A doll's form indicates the charm it carries—a rabbit doll gives speed to its owner's legs, while a bear gives strength of arms in combat. Human (and humanoid) dolls are good-luck tokens.

The power in a kani doll (if, indeed, it has any power at all) is directly related to the artistry and ritual of its creation. Many people can make attractive, real-looking dolls, but the rituals required to actually charm a doll, making it a kani doll, are known only to a few of the most remote tribes. Fewer still know how to create the evil perversions described here.

When a kani doll's creation is perverted to evil, it attacks that which it has been charmed to enhance. Thus, a rabbit doll might try to sever its victim's hamstrings, while a hawk doll would attempt to gouge out eyes. The statistics listed above are solely for these animated perversions; normally, kani dolls are quite harmless and inanimate.

The enchantment in some dolls activates them only at a certain time, or after a specific delay. Thus, a doll might activate seven nights after it was given as a gift, or only during a full moon.

Combat: In combat, a kani doll attacks with its mouth (or beak, etc.). If it scores a hit, it does 1d4 hp of damage and then continues to chew, inflicting an additional 1 hp of damage every round until its purpose is achieved or it is destroyed. If it manages to bite through its target, it disengages and begins seeking another victim. Thus, in the example above, if a rabbit doll severed its victim's hamstring, it would release its hold on that leg and seek out another leg—perhaps the other leg of its unfortunate victim! Since a doll has no mind, it can have no fear. Thus, it never checks morale, but always presses relentlessly to its target.

Of course, any of the stats listed above are variable, depending on the nature of each type of doll. A well-crafted rabbit doll is faster than other dolls, while a turtle doll has a better armor class. Some specific dolls have drawbacks, as well—turtle dolls crawl along at Move 2.

Sample dolls, their usual charm, and their targets:

Kani Doll	Charm	Target
Rabbit	speed	leg
Turtle	protection	head
Hawk	sight	eye
Cat	stealth	feet
Great cat	courage	vitals
Dove	love	heart
Bear	strength	arm
Owl	wisdom	brain
Raccoon	dexterity	hand
Human (humanoid)	luck	most vulnerable spot



KODRAGON

CLIMATE/TERRAIN:	Plane of the Astral Dragon
FREQUENCY:	Very rare
ORGANIZATION:	Solitary
ACTIVE TIME:	Any
DIET:	Any liquid
INTELLIGENCE:	Exceptional (15-16)
TREASURE TYPE:	Nil
ALIGNMENT:	Neutral (good tendencies)

NO. APPEARING:	1
ARMOR CLASS:	5
MOVEMENT:	6, Fl 24
HIT DICE:	5
THACO:	15
NO. OF ATTACKS:	3
DAMAGE/ATTACK:	1d2/1d2/1d6
SPECIAL ATTACKS:	Breath weapon
SPECIAL DEFENSES:	teleport and plane shift
MAGIC RESISTANCE:	Nil
SIZE:	Small (3' wingspan)
MORALE:	Very steady (13-14) (but see below)

XP VALUE: 2000

The kodragon is an extremely rare species of dragon that resides only on the plane of the Astral Dragon.

It resembles a dragon about the size of a house cat, but instead of scales, fine gray fur covers it from head to toe. It has leathery wings, a blunt snout, spindly arms and legs, and huge bulging, black eyes.

In addition to fur, the kodragon has other characteristics in common with mammals. Instead of laying eggs, the kodragon gives live birth and keeps its infant in a magical pouch on its belly. The pouch also functions like a *bag of holding* for the storage of items useful to the kodragon. Additionally, the kodragon has opposable thumbs which allow it to manipulate tools.

Combat: Kodragons avoid combat, but if cornered, they will attack with their claws and bite. They have two breath weapons; one is a 10-foot cloud of *shrinking gas* (shrinks the victim to 5% of normal size), the other is a 10-foot cloud of *cancellation of shrinking gas*, which negates the effects of the *shrinking gas* and restores the victim to normal size. Kodragons can also *teleport without error* and *plane shift* at will.

Habitat/Society: Kodragons are of neutral alignment, but some have tendencies towards good that they struggle to repress. They are patient, introspective, and deep thinkers. They make their lairs in remote areas of their plane and avoid contact with other creatures. The ideal lair for a kodragon is a small, empty island thousands of miles from all other life forms, including other kodragons.

Kodragons rarely use tools or weapons, but they are meticulous record-keepers. Many also have a remarkable aptitude for art. Their records and artworks are carved on clay-like square tablets, made from a special plant that grows only on their plane. Symbols are carved into the tablets with a stylus. All of these materials are easily stored in their pouches.

Ecology: Kodragons consume only liquids. Any liquid will do—mercury is as nourishing to them as water. They have no natural enemies; any creature that depended on a diet of these very rare and difficult-to-catch dragons would soon be extinct.



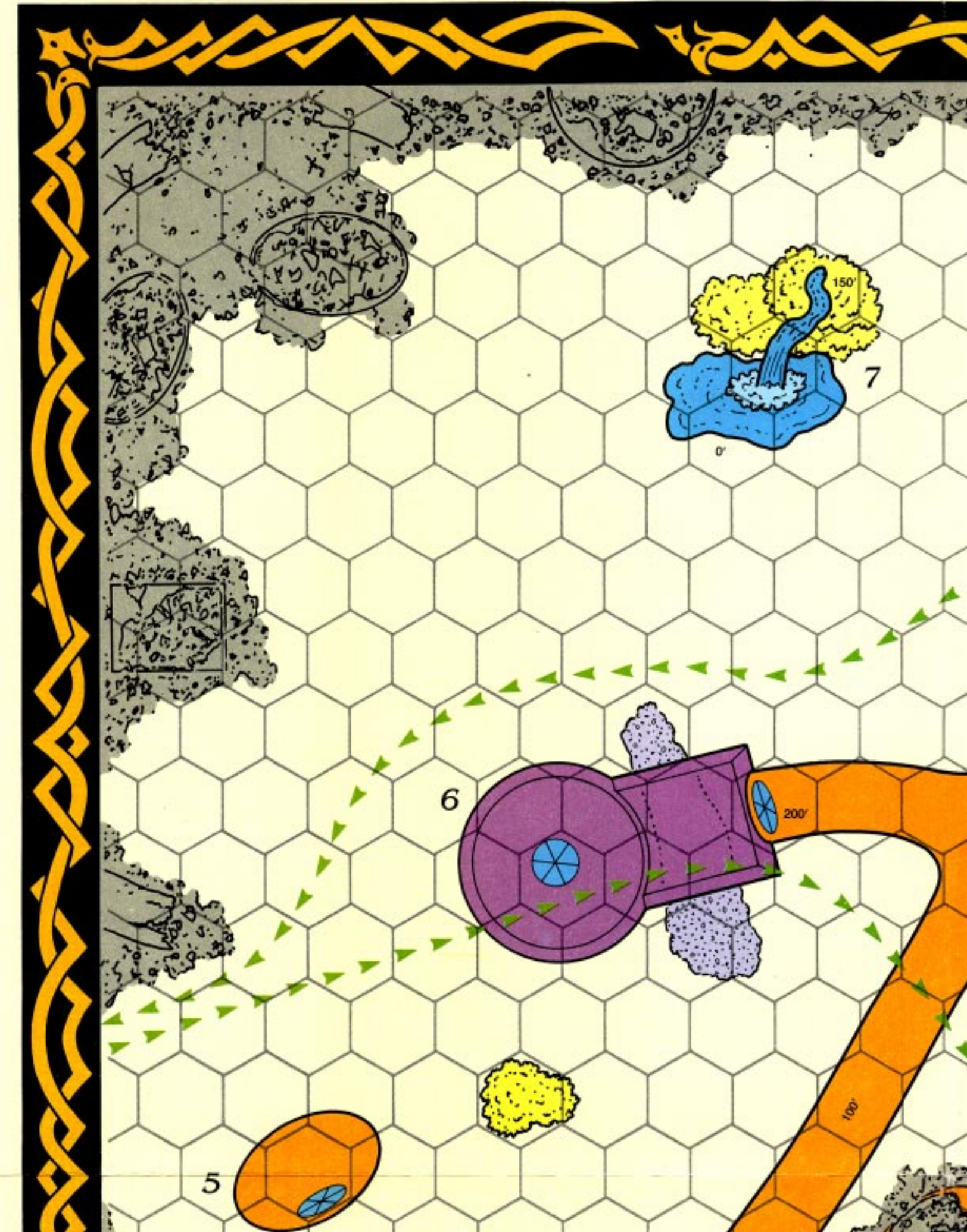

5

6

7

200'

100'

150'

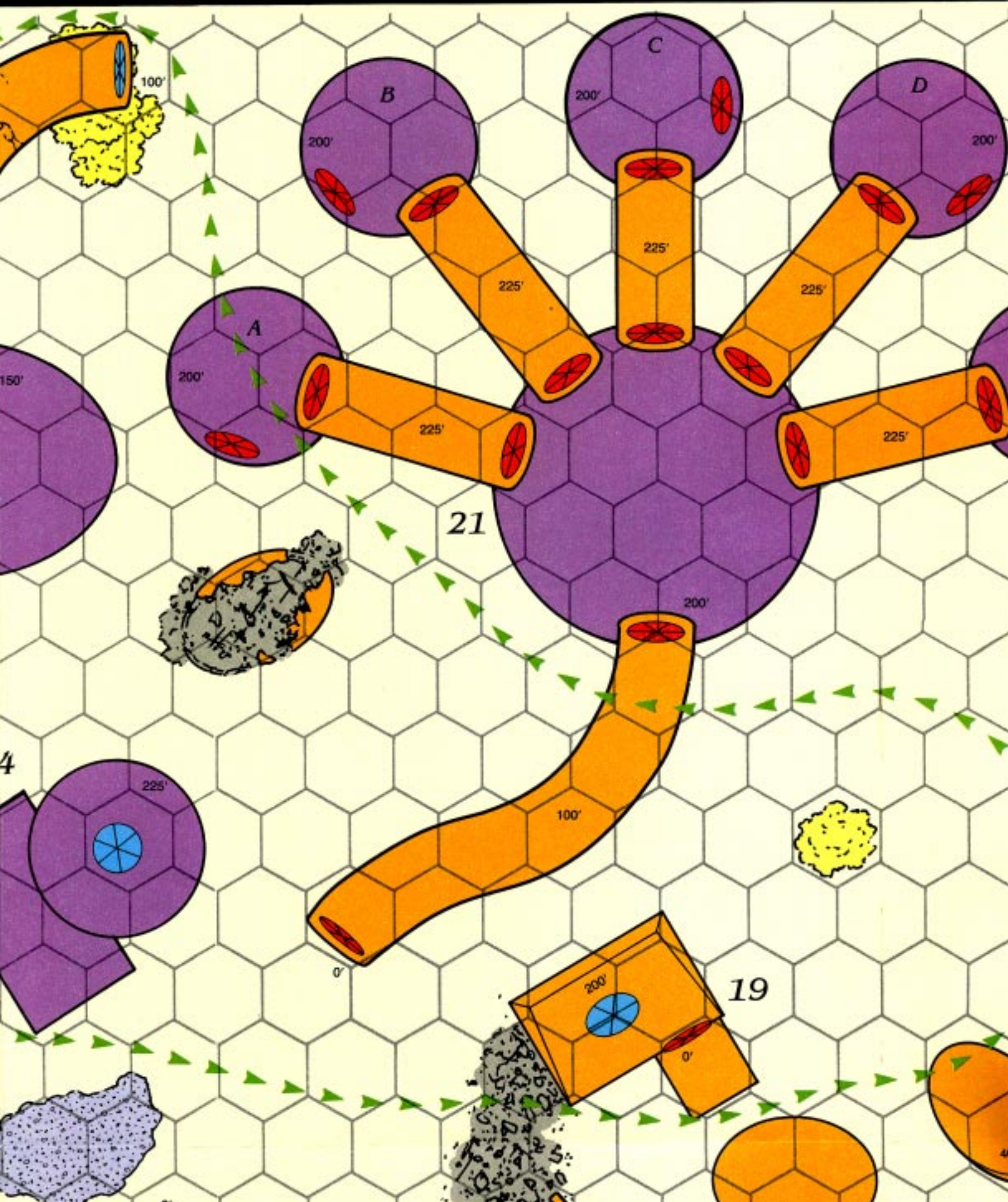

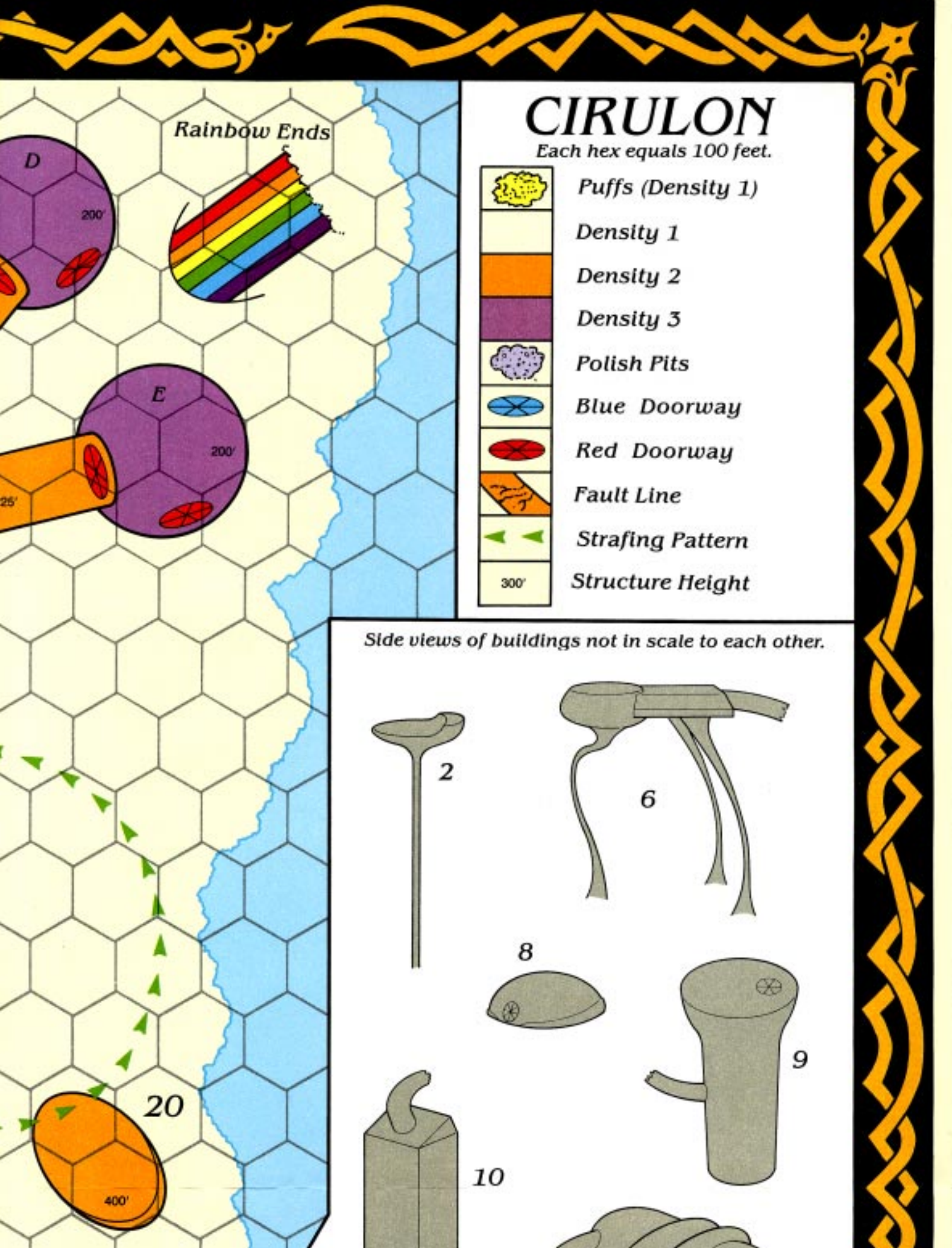





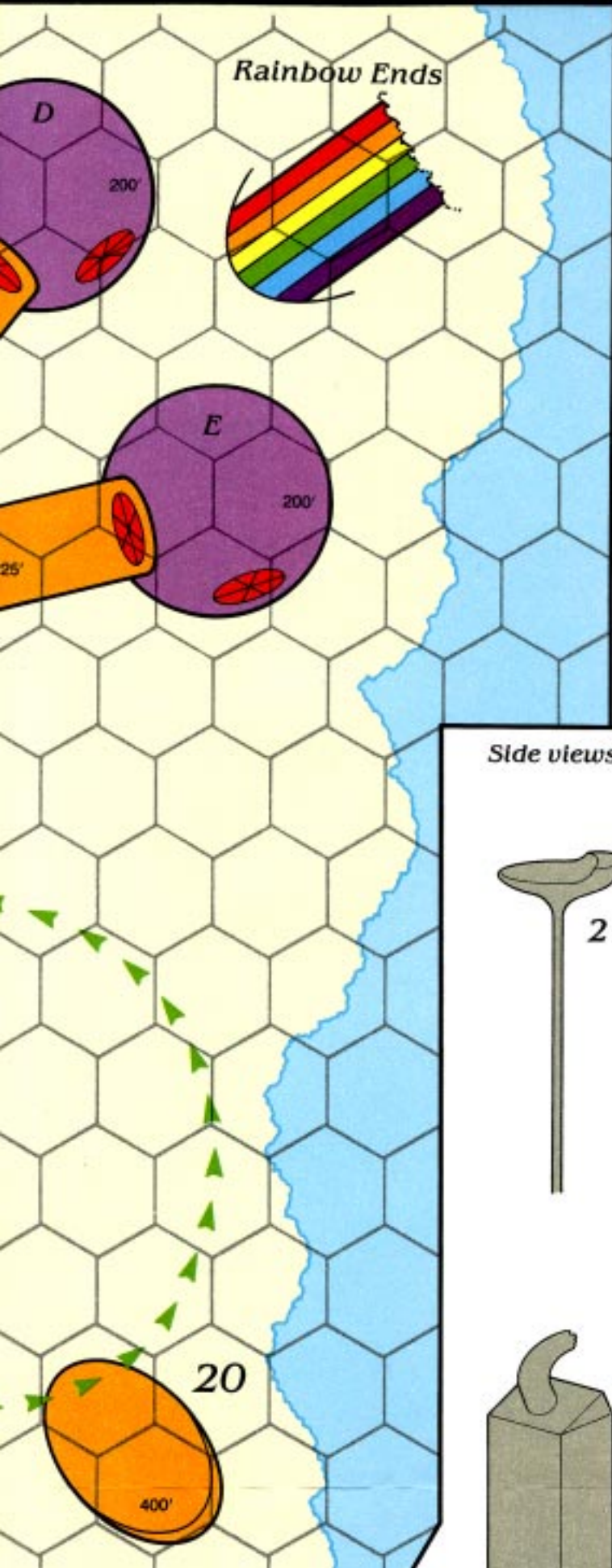

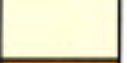

CIRULON

Each hex equals 100 feet.



	<i>Puffs (Density 1)</i>
	<i>Density 1</i>
	<i>Density 2</i>
	<i>Density 3</i>
	<i>Polish Pits</i>
	<i>Blue Doorway</i>
	<i>Red Doorway</i>
	<i>Fault Line</i>
	<i>Strafing Pattern</i>
	<i>Structure Height</i>

Side views of buildings not in scale to each other.

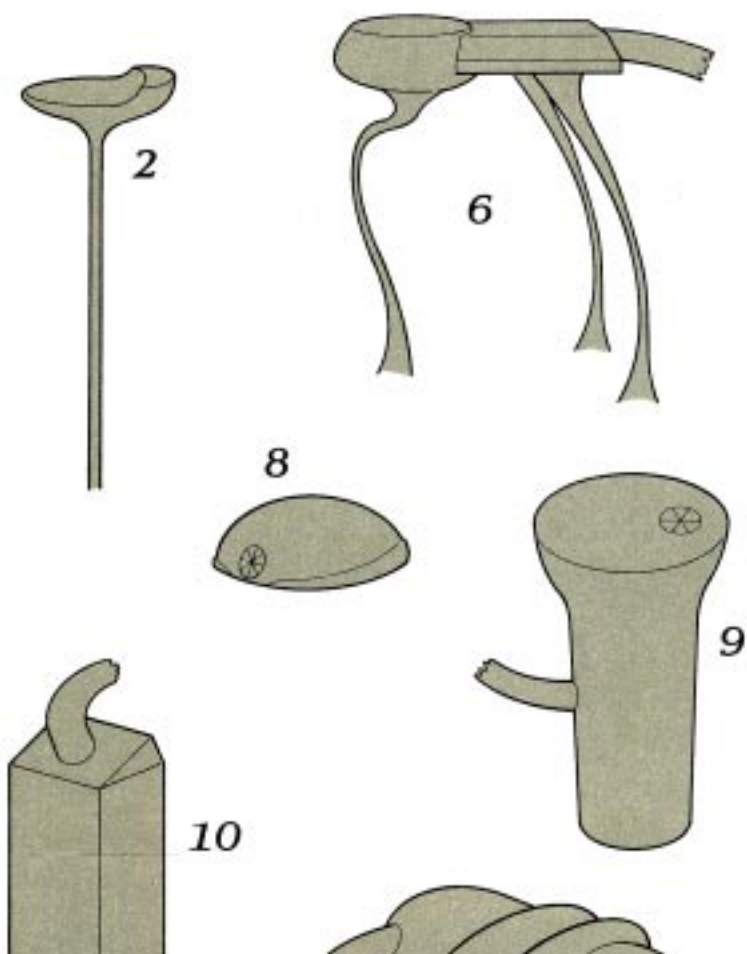

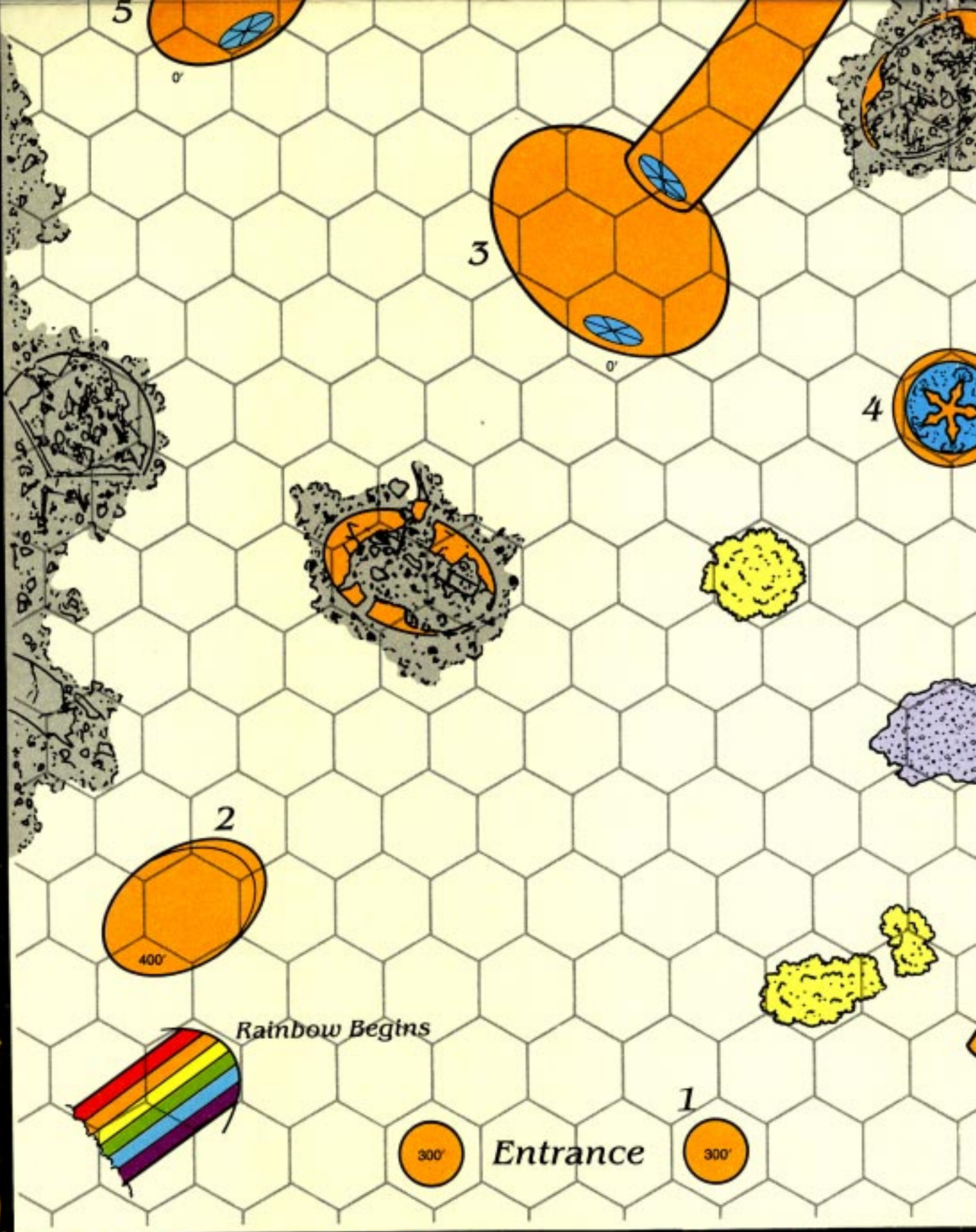

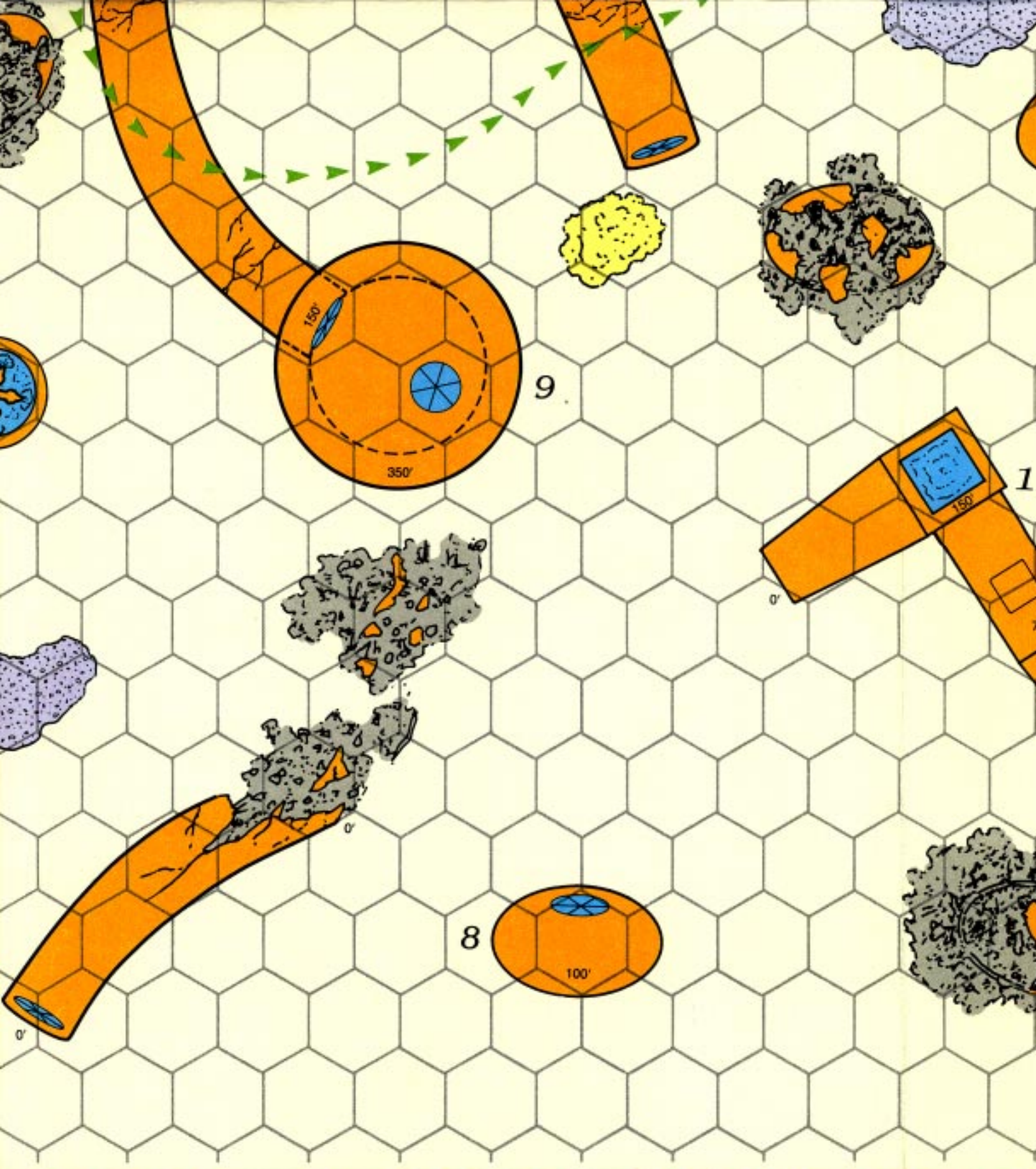

9

8

1

150'

350'

100'

150'

0'

0'

0'

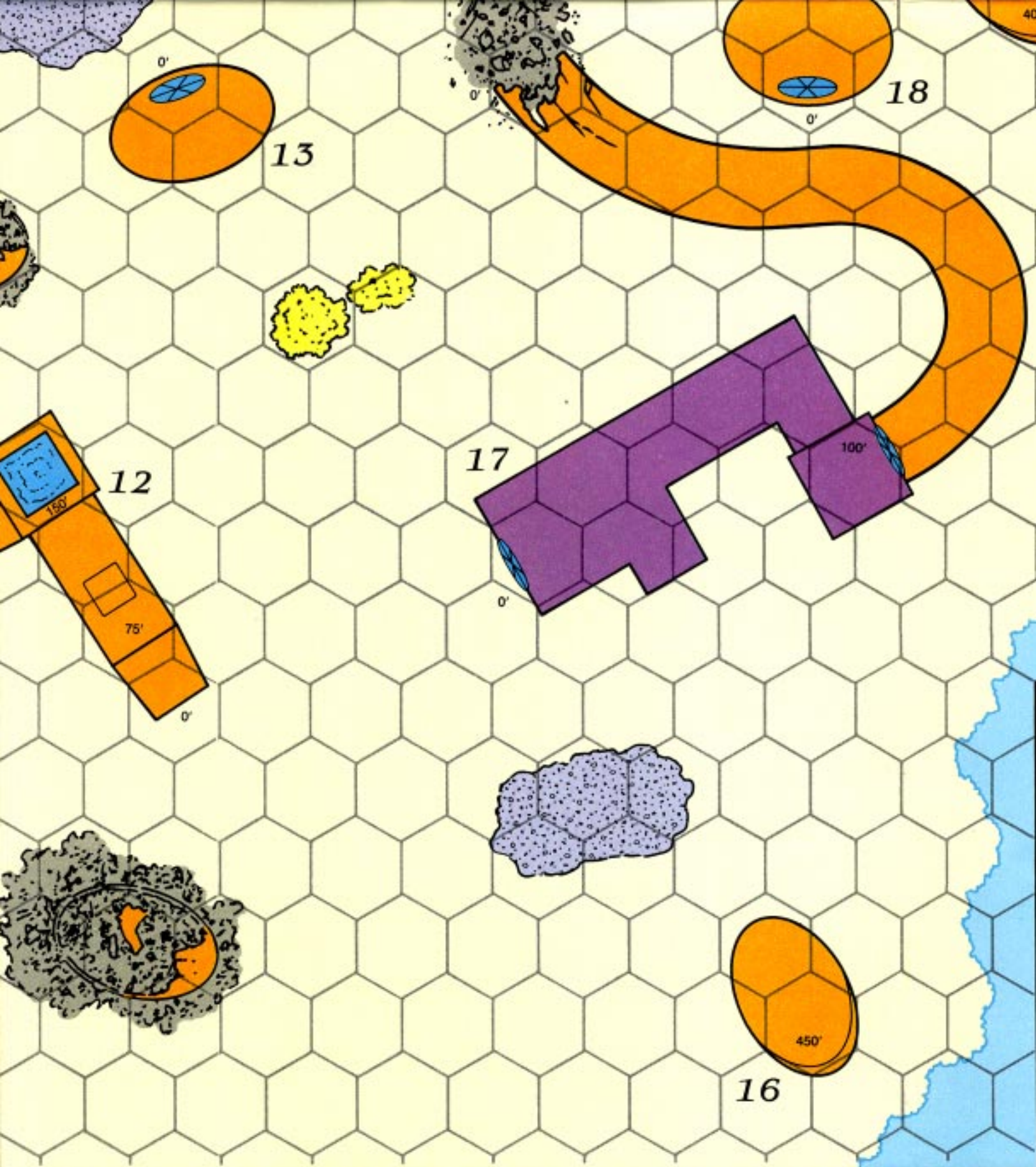

18

400'

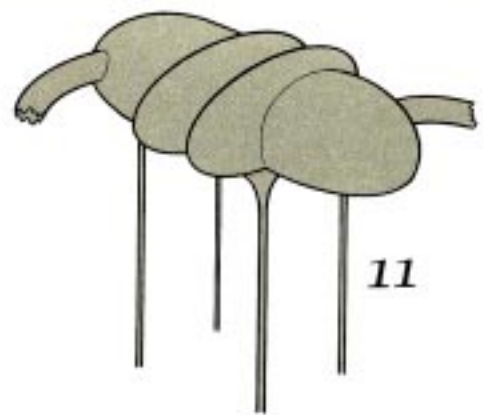

11

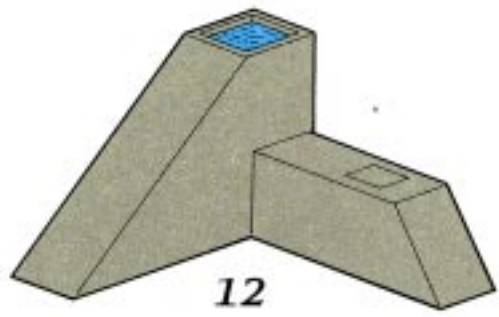

12

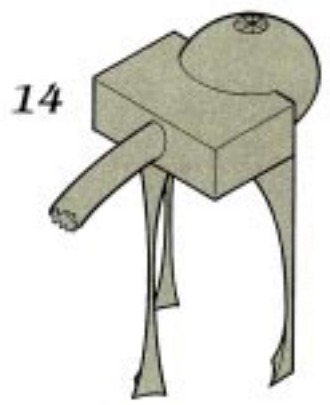

14

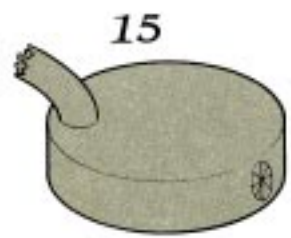

15

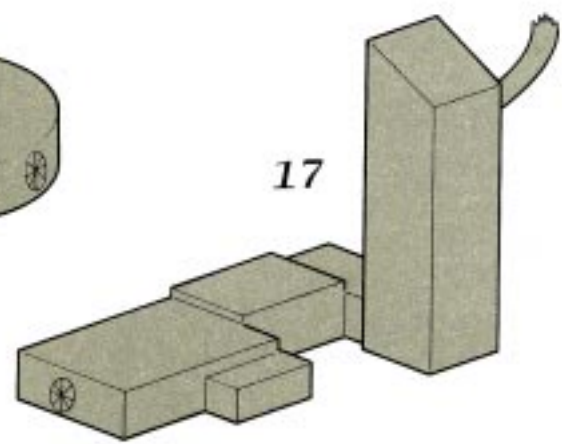

17

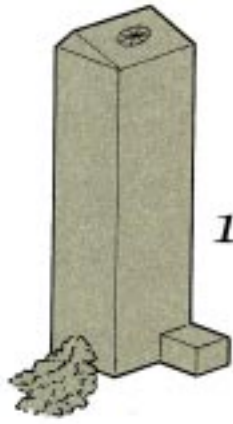

19

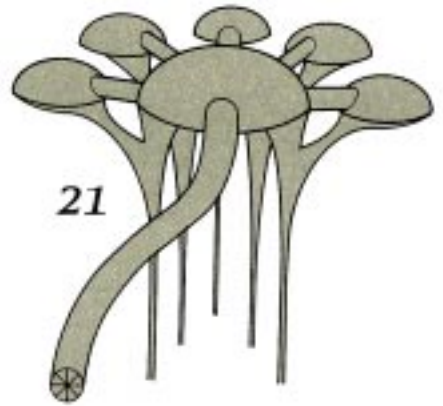

21

.....

Iryl is slight of frame and fair-skinned. She is very shy, seldom looking into the eyes of the person to whom she's speaking. She is especially tongue-tied around handsome males.

Iryl has a star-shaped birthmark in the center of her forehead. She is very self-conscious about the birthmark, believing that in some way it violates the Silvanesti philosophy of racial purity. She keeps her hair long to hide the birthmark as well as most of her face.

Iryl has an unflappable, almost naive confidence that good will inevitably triumph over evil. She is a tireless fighter, ready and willing to sacrifice her life in the pursuit of justice.

Weapon Proficiencies: Long Sword, Short Bow, Long Bow, Crossbow, Lance.

Other Proficiencies: Riding (land-based), Endurance, Swimming.

©1989 TSR, Inc. All Rights Reserved.
.....

As a young woman in Qualinost, **Grenden** was accused of a crime she didn't commit. Although eventually pronounced innocent, Grenden was still regarded with suspicion by many. Life in Qualinost became intolerable and Grenden left, never to return.

Grenden has been a nomad since then. She keeps others at arm's length and tends to see conspiracy where none exists. Sullen, distant, and moody, a smile on Grenden's face is as rare as a rose blossom in winter.

Grenden relishes battle, the bloodier the better. Although devoted to the cause of good, Grenden seldom shows mercy to enemies, including those she only assumes to be enemies.

Weapon Proficiencies: Long Sword, Short Sword, Staff, Javelin, Crossbow.

Other Proficiencies: Direction Sense, Fire Building, Fishing, Herbalism, Endurance.

©1989 TSR, Inc. All Rights Reserved.
.....

The handsome **Tarr** is a master bowman, an inveterate gambler, and a compulsive ladies' man. He flirts with Grenden incessantly, which infuriates Grenden as much as it delights Tarr.

Tarr relishes the life of an adventurer, openly mocking those who devote themselves to farming, commerce, and other mundane occupations. Some find Tarr's opinions hard to take, and more than once he's found himself on the receiving end of a peasant's fist.

Weapon Proficiencies: Long Bow (specialty), Long Sword, Short Sword, Axe, Short bow.

Other Proficiencies: Dancing, Fletcher, Gaming, Hunting, Running.

©1989 TSR, Inc. All Rights Reserved.
.....

Benny is a member of the Creat clan, born on the east coast of Nordmaar. Benny idolized his grandfather, a renowned explorer and prospector who claimed to have once discovered a mine of pure silver. Benny longed to follow in his grandfather's footsteps and ran away from home to do some prospecting of his own. He hasn't returned since. His journeys have taken him as far away as the forests of Ergoth and the minotaur caverns of Mithas.

Like most kender, Benny has an insatiable curiosity and an utter lack of fear, a combination that repeatedly gets him into trouble.

Weapon Proficiencies: Short Sword, Dagger, Thrown Dagger, Short Bow.

Other Proficiencies: Disguise, Mining, Reading Lips.

©1989 TSR, Inc. All Rights Reserved.
.....

Blackstar was raised by his father to become a warrior, as had been the family tradition for centuries. But after witnessing the devastation resulting from the War of the Lance, Blackstar abandoned his military training to become a cleric, believing Krynn already had more than enough soldiers. Blackstar was disowned by his family when he told them his decision.

Nevertheless, Blackstar has remained faithful to the true gods. He is a man of few words and seldom socializes. He is thoughtful and patient, intensely loyal to his friends and fair-minded with his enemies.

Weapon Proficiencies: Spear, Axe, Thrown Axe, Blowgun.

Other Proficiencies: Armor, Astrology, Leatherworking, Reading/Writing.

©1989 TSR, Inc. All Rights Reserved.
.....

Pike is an amiable, easy-going hill dwarf who is meticulous about his personal appearance. He can spend hours trimming and combing his curly brown hair and lengthy beard. He dislikes animals—they're too dirty—but is fond of his friends, particularly the ones who are free with their compliments.

Though not a coward, Pike prefers negotiation and retreat to direct combat, opting to fight only when there is no other choice. He always manages to hold up his end in a battle, though he never stops complaining about the damage to his fine clothes.

Weapon Proficiencies: Mace, Flail, Morningstar, Dagger, Spear, Sling.

Other Proficiencies: Etiquette, Gaming, Heraldry, Mountaineering, Tailor.

©1989 TSR, Inc. All Rights Reserved.
.....

Shalindra is a boisterous, fun-loving hunter, unflinching cheerful and optimistic. Her confidence masks a secret sorrow: As a child, Shalindra was the only survivor of a Red Dragonarmy ambush. She watched helplessly as her family was slaughtered before her eyes. Even now, Shalindra is prone to shattering nightmares, but she refuses to confide the reason to her friends.

Topping six feet in height with flowing blonde hair, Shalindra has no shortage of male admirers, but her heart belongs to Blackstar. So far, however, she has kept her feelings to herself.

Weapon Proficiencies: Sling (Specialty), Staff Sling, Long Sword, Thrown Dagger, Long Bow, Lance.

Other Proficiencies: Animal Handling, Animal Lore, Dancing, Hunting, Riding (land-based), Tracking.

©1989 TSR, Inc. All Rights Reserved.
.....

Trapian's father was a Solamnic Knight and his mother was a cleric of the Order of Solinari. When his father failed to return from the War of Lance, Trapian's mother encouraged him to use his intellectual gifts to study magic. Trapian has devoted himself to the rebuilding of Krynn in honor of his father.

Trapian enjoys the company of people. He likes nothing better than to spend the night around a campfire exchanging stories. He is a compulsive talker; many feel that Trapian would converse with the trees if there was no one else around to listen.

A sturdy man in his mid-30s, Trapian is a worthy ally on the battlefield. He is quick, clever, and fearless. If angered, he can be quite brutal.

Weapon Proficiencies: Staff, Sling.

Other Proficiencies: Ancient History, Ancient Languages, Artistic Ability, Reading/Writing, Religion, Spellcraft.

©1989 TSR, Inc. All Rights Reserved.
.....

BLACKSTAR *8th-level Human Cleric, male*

STR 13 **DEX** 14 **CON** 13 **THACO** 16
INT 14 **WIS** 16 **CHR** 16 **AL LG** **HP** 47

AC 8 (Leather Armor)

WEAPONS *Spear +2*

EQUIPMENT Medallion of Faith; as selected by player

ABILITIES Spell use (5 1st level, 5 2nd level, 3rd level, 2 4th level)

LANGUAGES Common, Plainsman

See back of card for more information.

PIKE OAKBONE *7th-level Dwarf fighter, male*

STR 16 **DEX** 11 **CON** 17 **THACO** 14
INT 9 **WIS** 12 **CHR** 12 **AL LG** **HP** 68

AC 1 (*Plate Mail +1* and Small Shield)

WEAPONS *Mace +1, Dagger*

EQUIPMENT As selected by player

LANGUAGES Common, Hill Dwarf

See back of card for more information.

SHALINDRA *9th-level Human Ranger, female*

STR 18/35 **DEX** 16 **CON** 14 **THACO** 12
INT 14 **WIS** 14 **CHR** 17 **AL LG** **HP** 56

AC 3 (*Leather Armor +2, Small Shield, Dex bonus*)

WEAPONS *Long Sword +2, Sling +1* and 20 Bullets

EQUIPMENT As selected by player

ABILITIES Spell use (2 1st level)

LANGUAGES Common, Plainsman, Qualinesti

See back of card for more information.

TRAPIAN *7th-level Human Mage, male*

STR 11 **DEX** 14 **CON** 13 **THACO** 18
INT 17 **WIS** 15 **CHR** 13 **AL LG** **HP** 24

AC 5 (*Staff of Power*)

EQUIPMENT *Staff of Power* (20 charges); as selected by player

ABILITIES Spell use (4 1st level, 3 2nd level, 2 3rd level, 1 4th level)

LANGUAGES Common, Solamnic, Plainsman, Hill Dwarf

See back of card for more information.

IRYL SONGBROOK *5th-level High Elf Fighter, female*

STR 10 **DEX** 13 **CON** 11 **THACO** 16
INT 15 **WIS** 14 **CHR** 13 **AL LG** **HP** 39

AC -2 (*Plate Mail +3, Shield +1*)

WEAPONS Short bow and Quiver of 20 Arrows

EQUIPMENT As selected by player

LANGUAGES Common, Silvanesti, Qualinesti, Plainsman

See back of card for more information.

GRENDEN *5th-level Elf Fighter/7th-level Elf Mage, female*

STR 17 **DEX** 16 **CON** 12 **THACO** 16
INT 14 **WIS** 11 **CHR** 14 **AL LN** **HP** 38

AC 2 (Chain Mail and Shield, Dex bonus)

WEAPONS *Long Sword +1*

EQUIPMENT As selected by player

ABILITIES Spell use (4 1st level, 3 2nd level, 2 3rd level, 1 4th level)

LANGUAGES Common, Qualinesti, Silvanesti, Plainsman

See back of card for more information.

TARR RAVENSEYE *8th-level Human Fighter, male*

STR 15 **DEX** 18 **CON** 15 **THACO** 13
INT 13 **WIS** 13 **CHR** 16 **AL LG** **HP** 50

AC -1 (Chain Mail Armor, *Shield +1, Dex bonus*)

WEAPONS Long Bow with 12 *arrows +1* and 20 normal arrows

EQUIPMENT As selected by player

LANGUAGES Common, Qualinesti, Solamnic, Hill Dwarf

See back of card for more information.

BENNYBECK CLOUDBERRY

9th-level Kender Thief, male

STR 10 **DEX** 17 **CON** 14 **THACO** 16
INT 10 **WIS** 9 **CHR** 11 **AL N** **HP** 39

AC 5 (Leather Armor)

WEAPONS Short Sword, Dagger

EQUIPMENT As selected by player, plus thieves tools

LANGUAGES Kender, Common

See back of card for more information.

MONSTERS

Bat (60): AC 8; MV 1, FI 24; HD 1; hp 1d2 each; #AT 1; Dmg 1; AL N; THACO 20.

Boring beetle (2): AC 3; MV 6; HD 5; hp 34, 30; #AT 1; Dmg 5d4; AL N; THACO 15.

Emre: AC 7; MV 18, FI 24 (can stay airborne for no more than 10 consecutive rounds); HD 3; hp 20 each; #AT 1 or 1; Dmg 1d4 (peck) or 2d4 (kick); AL N; THACO 16.

Exploding skeleton: AC 7; MV 12; HD 1; hp 8 each; #AT 1; Dmg 1d6 (sword); SA explode (see below); SD sharp and/or edged weapons do half-damage, immune to *sleep*, *charm*, *hold*, and cold-based attacks; AL N; THACO 19.

The powerful magic that transformed the tower also affected its skeletons by infusing them with the draconian essence of Khardra. If a skeleton is reduced to 0 (or fewer) hit points, its bones explode, causing 1d6 hp of damage to all within 10 feet (no saving throw).

Eyewing: AC 4; MV FI 24; HD 3; hp 17 each; # AT 3 or 1; Dmg 1d6/1d6/1d4 or eyewing tears; SA blinks eyewing tears (same chance to hit as normal attack at target within 100 feet) which also splashes in 10-foot radius. Victims must save vs. poison: suffer 2d6 hp if roll fails and 1d6 hp if roll succeeds (splashed victims suffer 2d4 hp if roll fails and 1d4 if roll succeeds); SD immune to all cold-based attacks; AL LE; THACO 16.

Harpy (2): AC 7; MV 6, FI 15; HD 3; hp 22, 19; #AT 3; Dmg 1d3/1d3/1d6 (weapon); SA singing (victim proceeds toward harpy unless he saves vs. magic) and charm; AL CE; THACO 16.

Giant ant: AC 3; MV 18; HD 2; hp 15; #AT 1; Dmg 1d6; AL N; THACO 16.

Giant constrictor (snake): AC 5; MV 9; HD 6 + 1; hp 40; #AT 2; Dmg 1d4/2d4; SA constriction; AL N; THACO 13.

Giant eel: AC 6; MV Sw 9; HD 5; hp 38; #AT 1; Dmg 3d6; AL N; THACO 15.

Giant octopus: AC 7; MV 3, Sw 12; HD 8; hp 35; #AT 7 (6 in this case, as one tentacle holds the boy); Dmg 2d6 (bite)/1d4 (x 5) (tentacles); SD if 3 tentacles severed, 90% chance of retreat behind ink cloud 4" high x 6" wide x 6" long, completely obscuring the underwater vision of any creature within it; AL N(E); THACO 12.

Giant porcupine (2): AC 5; MV 6; HD 6; hp 40, 37; #AT 1; Dmg 2d4; SA shoot quills (30' range, dmg 1d4); SD quills (any attacker within 6 feet, 1d4 quills (dmg 1d4 per quill)); AL N; THACO 13.

Giant Two-Headed Troll: AC 4; MV 12; HD 10; hp 57; #AT 3 (4); Dmg 1d6/1d6/1d10/(1d10); SD regenerate 1 hp per round; THACO 10.

Ghoul (2): AC 6; MV 9; HD 2; hp 14 each; #AT 3; Dmg 1d3/1d3/1d6; SA touch causes *paralyzation* unless victim saves vs. *paralyzation*; SD immune to *sleep* and *charm*; AL CE; THACO 16.

Hieracosphinx: AC 1; MV 9, FI 36; HD 9; hp 50 each; #AT 3; Dmg 2d4/2d4/1d10; AL CE; THACO 12.

Homunculous: AC 6; MV 6, FI 18; HD 2; hp 10 each; #AT 1; Dmg 1d3; SA bitten victim must save vs. magic or fall into comatose sleep (5d6 minutes); SD makes all saves as 18th level mage; THACO 16.

Imp: AC 2; MV 6, FI 18; HD 2 + 2; hp 16; #AT 1; Dmg 1d4; SA suggestion once per day; SD *polymorph* at will (large spider, raven), *invisible* at will, affected only by silver or magical weapons (unaffected by magical attacks employing cold, fire, or electricity and are considered 7 HD creatures for the

purposes of spell attacks), *regenerate* 1 hp per round; AL LE; THACO 16.

Juju zombie: AC 6 (Pavasusu: AC 4 from corn-like skin); MV 9; HD 3 + 12; hp 30 each; Dmg 3d4; SA attacks as 6 HD monster; SD only affected by +1 or better magical weapons, fire has only one-half normal effect, piercing and blunt weapons do half damage, immune to *illusion*, *charm*, *hold*, *magic missile*, *death*, *cold*, poison and electricity; AL N(E); THACO 16 (modified to 13).

Kani doll: AC 10; MV 6*; HD 2; hp 10 each*; #AT 1; Dmg 1d4 (bite); SA if an attack hits, the head stays attached to victim and causes an additional 1 hp of damage in each successive round until the doll is destroyed; AL CE; THACO 16.

*Mudhole dolls as above, but MV 0; hp 4 each.

Ochre jelly: AC 8; MV 3; HD 6; hp 42; #AT 1; Dmg 3d4; SD can flow along walls and ceiling, *lightning bolts* divide it, each part doing half damage; AL N; THACO 13.

Pegasus (one per PC): AC 6; MV 24, FI 48; HD 4; hp 25 each; #AT 3; Dmg 1d8/1d8/1d3; AL CG; THACO 15.

Rat (10): AC 7; MV 15; HD 1/4; hp 2 each; #AT 1; Dmg 1; AL N(E); THACO 20.

Shadow: AC 7; MV 12; HD 3+3; hp 21; #AT 1; Dmg 1d4 + 1; SA each hit saps 1 point of victim's Strength (recoverable 2d4 turns after being hit), victim becomes Shadow if Strength or hit points reduced to zero; SD only +1 or better weapons will hit, unaffected by *sleep*, *charm*, *hold*, and cold-based attacks, 90% undetectable without bright light; AL CE; THACO 16.

Skeleton: AC 7; MV 12; HD 1; hp 8 each; #AT 1; Dmg 1d6 (sword); SD sharp and/or edged weapons do half-damage, immune to *sleep*, *charm*, *hold*, and cold-based attacks; AL N; THACO 19.

Skull Mask (Qahitloq's Death Mask): AC 7; MV FI 24; HD 2; hp 15; #AT 1; Dmg 1d6 (bite); AL CE; THACO 16.

Stirge (4): AC 8; MV 3, FI 18; HD 1 + 1; hp 8, 7, 7, 6; #AT 1; Dmg 1d3; SA attacks as if 4 HD creature, each round after striking it drains blood equal to 1d4 hp until it has drained 12 hp worth of blood (after which it retreats); AL N; THACO 18.

Strangle weed: AC 6; MV nil; HD 4; hp 30; #AT 1; Dmg see below; SA see below; AL N; THACO 15.

Has ten 12-foot-long fronds, each with Strength 4d4. A hit indicates the victim is entwined by a frond. Anyone entwined by one or more fronds compares his Strength against that of the frond or fronds entwining him. The difference in the victim's favor is his chance of escaping (1 = 10%, 2 = 20%, etc.). A difference in favor of the weed indicates the victim has taken that much crushing damage (if the victim has a Strength of 15 and two fronds entwining him have a total of 25 Strength points, the victim suffers 10 hp of damage). Entwined PCs attack at -2.

Water weird: AC 4; MV Sw 12; HD 3 + 3; hp 18; #AT 0; Dmg nil; SA drowning; SD sharp weapons do only 1 hp of damage, damage equal to its total hp disrupts it, reappears two rounds after disruption, *cold* spells slow it, *fire*-based spells do half or no damage, *purify water* spell kills it, immune to all other attacks; AL CE; THACO 13 (attacks as 6 HD monster).

Wight: AC 5; MV 12; HD 4 + 3; hp 30; #AT 1; Dmg 1d4; SA *energy drain* (victim loses one life level with each successful hit); SD only affected by silver or magical weapons, unaffected by *sleep*, *charm*, *hold*, cold-based spells, *paralyzation*, and poison; AL LE; THACO 15.

Zombie (4): AC 8; MV 6; HD 2; hp 15, 14, 13, 13; #AT 1; Dmg 1d8; SD immune to *sleep*, *charm*, *hold* and cold-based spells; AL N; THACO 16.

Advanced Dungeons & Dragons[®]
2nd Edition



DRAGON MAGIC



The Moons of Krynn are fading. The alignment forces of Good, Evil, and Neutrality are locked in conflict. . . and evil seems to be winning! The unnatural machinations of the treacherous Khardra—daughter of Takhisis herself!—have led to a crisis of cosmic proportions.

The Heroes journey to the Cloud City Cirulon, heart of the Good Dragon races, there

to meet the Astral Dragon himself. The nature of a plague claiming the lives of silver dragonhood is revealed, and the cure is presented to the companions. But the road to success is fraught with peril, the only route leading through a secret portal. If this portal becomes known to the forces of evil, disaster will surely result.

This AD&D[®] adventure, set in the world of the DRAGONLANCE[®] saga, follows DLE1 — In Search of Dragons. Some burning questions are answered but more are raised. And as the players investigate, the knowledge they gain seems to point more and more to a sinister threat of evil undreamed of since the War of the Lance.



TSR, Inc.
PRODUCTS OF YOUR IMAGINATION

\$8.95 U.S.



ISBN 0-88038-740-3

TSR, Inc.
POB 756
Lake Geneva
WI 53147 U.S.A.

TSR Ltd.
120 Church End, Cherry Hinton
Cambridge CB1 3LB
United Kingdom

© 1989 TSR, Inc. All Rights Reserved. Printed in the U.S.A.

ADVANCED DUNGEONS & DRAGONS, AD&D, DRAGONLANCE,
PRODUCTS OF YOUR IMAGINATION, and the TSR logo are
trademarks owned by TSR, Inc.